



Innsbrook Traditional & Loft Contemporary Vent-Free Fireplace Inserts

Innsbrook 28,000 Btu Vent-Free Fireplace Insert shown with optional 6 x 6-inch Metal Surround and Arch Louvers in Hammered Pewter.



Vent-Free Fireplace Inserts



Innsbrook 20,000 Btu Vent-Free Fireplace Insert shown with optional 6 x 6-inch metal surround.

Benefits of an Insert

A vent-free gas insert turns your existing wood-burning fireplace into an attractive and efficient heat source.

Vent-free fireplace inserts are classified as zone heating appliances. Zone heating is inherently more efficient than your existing wood-burning fireplace or your central furnace. A central furnace wastes 20 to 30 percent of the heat energy through ductwork losses and sends much of the remaining heat to unoccupied rooms.

Zone heating creates and transmits heat directly into the room. This lets you turn down your whole-house thermostat and use your fireplace insert to efficiently warm the room you use most.

All of our vent-free inserts feature an Oxygen Depletion Sensor (ODS) to instantly shut off the burner if oxygen levels drop to unsafe levels.

Don't have an existing fireplace? These vent-free systems are also certified for zero-clearance installation in any wall. Just add one of our available surrounds to create an attractive in-wall fireplace.

Features

Standard Features

We offer Vent-Free Inserts in two sizes (20,000 Btu and 28,000 Btu) and in two styles (traditional and contemporary) – so you are sure to find one to fit your existing wood-burning fireplace.

A 10,000 Btu contemporary system is available for bedroom applications – where allowed by codes.

Our Innsbrook Vent-Free inserts feature Banded Brick Liners, with hand-painted ceramic fiber logs nestled atop the variable-flame burner, to create an exceptionally attractive traditional fireplace. The unique Slope Glaze Flair Burner produces natural flickering flames that dance and delight – warming your heart as it warms your soles.

The Loft Series Vent-Free Insert features a contemporary linear burner in a porcelain lined firebox that reflects the flames to create depth and visual interest.

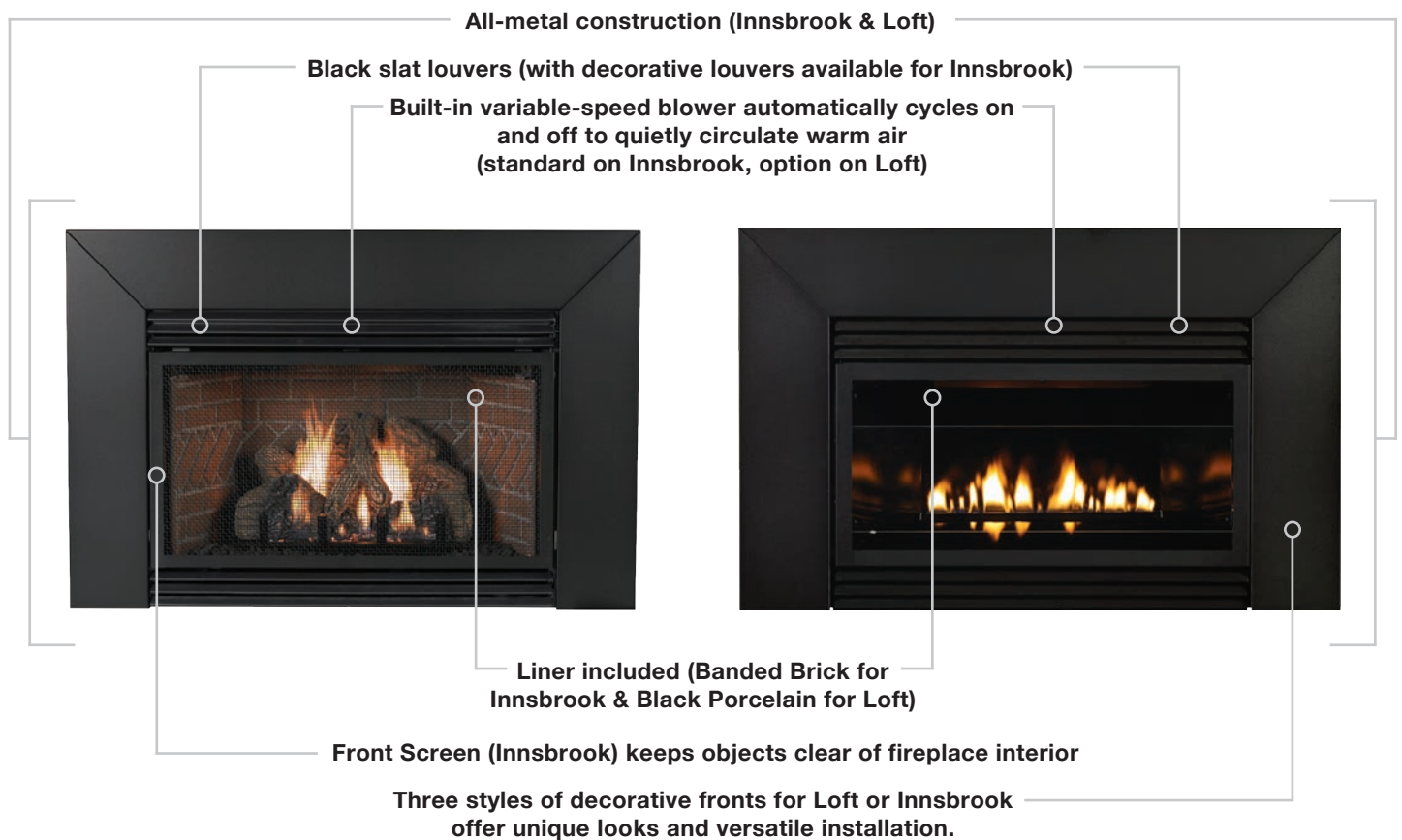

Options & Accessories

Surrounds & Shrouds

Your new Vent-Free insert will require a surround kit to conceal the original fireplace opening. For **Traditional** models, choose one of our steel surrounds with either 6-inch top and side panels or 6-inch top and 3-inch side panels.

For installations where your Innsbrook traditional insert does not rest on the hearth, we offer a 1 5/16-inch bottom cover to complete the surround.

To cover larger hearth openings, install the optional shroud. At 48 inches wide and just under 38 inches tall, it provides a clean transition between the surround and the existing fireplace. We offer a 2-inch bottom cover to complete the shroud.



S256BL 6 x 6-inch Metal Surround shown with 20,000 Btu Vent-Free Innsbrook



S253BL 6 x 3-inch Metal Surround shown with 20,000 Btu Vent-Free Innsbrook



DF28GBL Tempered Glass Surround shown with 28,000 Vent-Free Btu Innsbrook

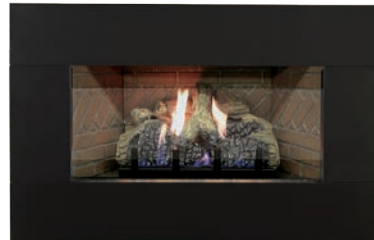

DF28MBL Contemporary 4-Sided Metal Frame shown with 28,000 Btu Vent-Free Innsbrook

For the **Traditional or Loft** VF Insert, choose a contemporary three-sided surround or four-sided matte black metal or tempered glass surround.



DF20GBL Tempered Glass Surround shown with 20,000 Btu Vent-Free Loft



DF20MBL Contemporary Style 4-sided Metal Surround shown with 20,000 Btu Vent-Free Loft



DF20LBL Metal Surround with Glass and Louvers shown with 20,000 Btu Vent-Free Loft

Options & Accessories

Surround and Shroud Dimensions

Model	Description	Surround Color	A	B	C	D	E	F	Fits Models
S256BL	6 x 6-inch Metal Surround	Matte Black	25 5/8	40	1 3/4	19 5/8	28	6	VFP20IN
S336BL	6 x 6-inch Metal Surround	Matte Black	28 5/8	43	1 3/4	22 5/8	31	6	VFP28IN
S253BL	6 x 3-inch Metal Surround	Matte Black	25 5/8	34	1 3/4	19 5/8	28	6	VFP20IN
S333BL	6 x 3-inch Metal Surround	Matte Black	28 5/8	37	1 3/4	22 5/8	31	6	VFP28IN
DF20LBL	6 x 6-inch Metal Surround with Glass and Louver	Matte Black	25 5/8	40	1 3/4	-	-	-	VFP20IN / VFL20IN
DF28LBL	6 x 6-inch Metal Surround with Glass and Louver	Matte Black	28 5/8	43	1 3/4	-	-	-	VFP28IN / VFL28IN
DF20MBL	4-sided Metal Frame with Glass (For in-wall installation only)	Matte Black	23 1/2	37 5/8	2 3/8	-	-	-	VFP20IN / VFL20IN
DF28MBL	4-sided Metal Frame with Glass (For in-wall installation only)	Matte Black	26 1/2	40 5/8	2 3/8	-	-	-	VFP28IN / VFL28IN
DF20GBL	Tempered Glass	Matte Black	20 1/2	34	4 7/16	-	-	-	VFP20IN / VFL20IN
DF28GBL	Tempered Glass	Matte Black	23 1/2	37	4 7/16	-	-	-	VFP28IN / VFL28IN
SH1BL	Universal Shroud (Fits behind surround for insert installations)	Matte Black	37 7/8	48	1/2	23 7/8	36	12	S256BL, S336BL, SC256BL, SC336BL, DF20LBL, DF28LBL

VFP Inserts Only

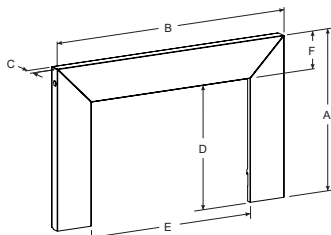

S(25/33)6BL
6 x 6-inch Metal Surround

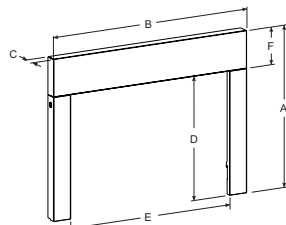

S(25/33)3BL
6 x 3-inch Metal Surround

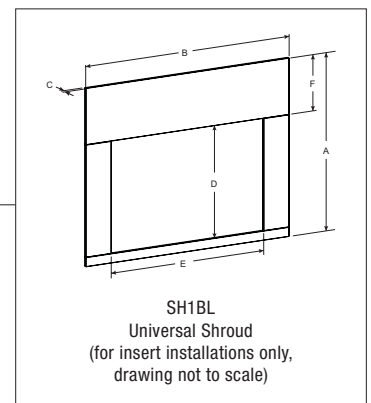

VFL or VFP

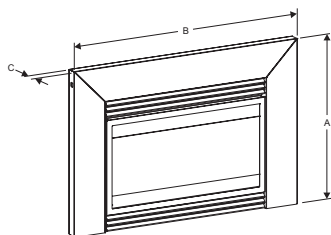

DF(20/28)LBL
6 x 6-inch Metal Insert Surround
with Glass and Louver

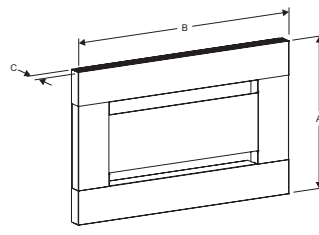

DF(20/28)MBL*
4-sided Metal In-Wall Frame
with Surround with Glass

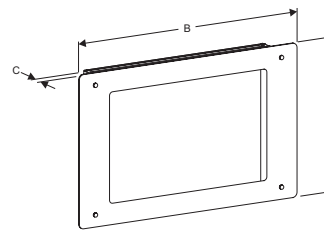

DF(20/28)GBL*
Tempered Glass In-Wall Surround

* In-Wall Surrounds may be used for Insert installations if the clearance to the floor is 5 inches or more.

Options & Accessories

Decorative Media for Loft Inserts

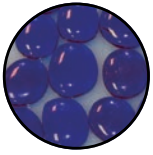

Topaz Clear Drops
One-inch



Onyx Solid Drops
One-inch

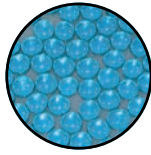

Aqua Blue Droplets
1/2-inch

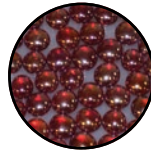

Sangria Luster Droplets
1/2-inch



Glacier Ice Droplets
1/2-inch

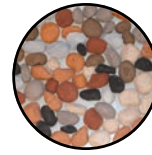

Accent Pebbles

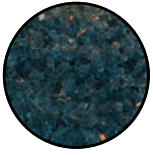

Blue Clear
Crushed



Clear Frost
Crushed



Black Polished
Crushed

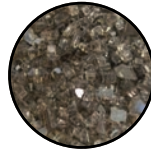

Bronze Reflective
Crushed



Copper Reflective
Crushed



Medium Rocks

Loft 20,000 Btu Vent-Free Fireplace Insert
shown with optional Decorative Glass Front.



Options & Accessories

Control Options for Millivolt Vent-Free Inserts

Lighting and managing a wood fire takes time and work – and more than a little patience to get it right. Your Innsbrook or Loft fireplace insert lights at the flick of a switch to produce consistent, reliable heat, even when electric power fails. Add the convenience of an optional thermostat, wireless wall thermostat, remote control, or thermostat remote control, and enjoy all the comfort of a warm cozy fire without the mess and hassle.



FRBC
Remote



FREC
Electric Remote Control



FRBTC
Thermostat Remote Control



FRBTP
Programmable Remote Control



FWS
Wall Switch



TRW Wireless
Wall Thermostat



TMV
Wall Thermostat



TDV Digital
Wall Thermostat

Decorative Louvers for Traditional Vent-Free Inserts

With three styles and two finishes from which to choose, our decorative louvers help create the perfect look for your Innsbrook traditional fireplace insert.

Finishes include our rich matte black and contemporary hammered pewter.

In addition to the traditional slat louvers, we offer a graceful Arched pattern and a geometric Mission pattern.

All of our decorative louvers install in seconds without tools.



Decorative Louver Arch



Decorative Louver Mission

Traditional Vent-Free Insert Dimensions

Model	A	B	C	D	E	F	G	H	I	J	K	L	M	N
VFP20IN	19 3/4	28	14 1/2	11 3/8	25 1/2	12 3/4	16	18 5/16	26 3/8	-	-	20	25 3/4	40
VFP28IN	22 3/4	31 1/16	16	14 3/4	28 1/2	14 1/4	18	21 5/16	30	-	-	21 1/2	28 3/4	43
VFL20IN	19 3/4	28	14 1/2	11 3/8	25 1/2	12 3/4	16 3/16	18 1/8	26 3/8	-	-	20	25 3/4	40
VFL28IN	22 3/4	31 1/16	16	14 3/4	28 1/2	14 1/4	18	21 1/8	30	-	-	21 1/2	28 3/4	43

* Note: Illustrations shown are based on Vent-Free models with 6 x 6-inch metal surround.

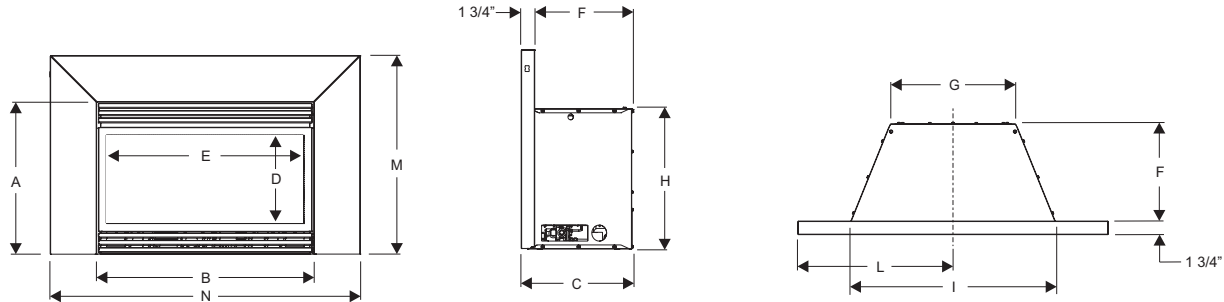

Minimum Fireplace Opening Dimensions

Model	A	B	C	D
VFP20IN	18 1/2	26 3/4	13 3/4	16 1/4
VFP28IN	21 1/2	30 3/4	15 3/16	18
VFL20IN	19 1/4	26 3/4	12 3/4	15 3/4
VFL28IN	22 1/4	30 3/4	14 1/4	19

*Note: These are the minimum dimensions of a fireplace that the fireplace insert will fit into. It allows room for the box and the fireplace surround to fit onto the front of the unit. It is not intended to be used for framing dimensions.

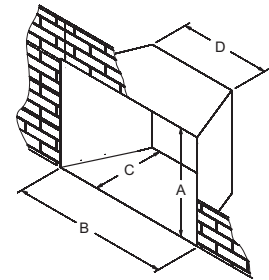

Gas Inlet		Vent-Free Warranty
Type of Gas	Natural or LP	All Vent-Free products carry a 5-year limited warranty with a 5-year limited labor warranty. All remote controls carry a 1-year limited warranty.
Iron Pipe Size (N.P.T.)	1/2 inch	
Ignition Systems	Standing Pilot/Piezo or Intermittent Pilot	

Empire is committed to continuous product improvement; specifications are subject to change without notice. Dimensions in this brochure are approximate; read and follow the framing dimensions in the owners manual supplied with your Empire product. Flame size, shape, and color will vary from photos.

Member of the following industry associations:



This appliance is design-certified to the ANSI standard by:



SINCE 1932

Empire Comfort Systems Inc.
918 Freeburg Ave.
Belleville, IL 62220-2623
info@empirecomfort.com

WMH-00901 5/01/18

The Empire Comfort Systems and White Mountain Hearth names and logos are registered U.S. trademarks.