

INSTALLATION INSTRUCTIONS AND OWNER'S MANUAL

Vented/Vent-Free Burner

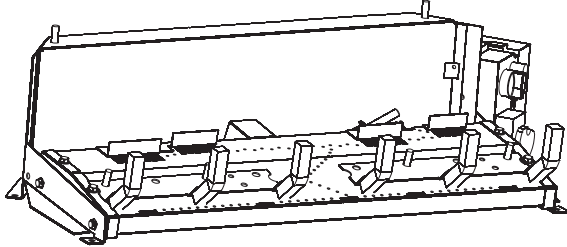

INSTALLER:

Leave this manual with the appliance.

CONSUMER:

Retain this manual for future reference.

⚠ WARNING

FIRE OR EXPLOSION HAZARD

Failure to follow safety warnings exactly could result in serious injury, death or property damage.

- Do not store or use gasoline or other flammable vapors and liquids in the vicinity of this or any other appliance.
- **WHAT TO DO IF YOU SMELL GAS**
 - Do not try to light any appliance.
 - Do not touch any electrical switch; do not use any phone in your building.
 - Leave the building immediately.
 - Immediately call your gas supplier from a neighbor's phone. Follow the gas supplier's instructions.
 - If you cannot reach your gas supplier, call the fire department.
- Installation and service must be performed by a qualified installer, service agency or the gas supplier.

⚠ WARNING

If not installed, operated and maintained in accordance with the manufacturer's instructions, this product could expose you to substances in fuel or from fuel combustion which can cause death or serious illness.

UNVENTED GAS LOG HEATER OR INTERMITTENT MODELS

VFSE-(18,24,30)-1

VARIABLE MODELS

VFSV-(16,18,24,30)-4

VENTED

DECORATIVE APPLIANCE

VARIABLE MODELS

VFSV-(16,18,24,30)-4



This is an unvented gas-fired heater. It uses air (oxygen) from the room in which it is installed. Provisions for adequate combustion and ventilation air must be provided. Refer to page 11.

WATER VAPOR: A BY-PRODUCT OF UNVENTED ROOM HEATERS

Water vapor is a by-product of gas combustion. An unvented room heater produces approximately one (1) ounce (30ml) of water for every 1,000 BTU's (.3KW's) of gas input per hour. Refer to page 44.

This appliance may be installed in an aftermarket permanently located, manufactured (mobile) home, where not prohibited by local codes. This appliance is only for use with the type of gas indicated on the rating plate. This appliance is not convertible for use with other gases.

NATIONAL
FIREPLACE
INSTITUTE



CERTIFIED
www.nficertified.org

We suggest that our gas hearth products be installed and serviced by professionals who are certified in the U.S. by the National Fireplace Institute® (NFI) as NFI Gas Specialists.

BEFORE YOU START

1. Read the safety information on pages 4 and 5.
2. Air shutter setting, see pages 7 and 8.
3. Fireplace sizing and clearances, see pages 11-13.
4. Install the burner. See page 15.
5. Gas supply. See page 17.
6. Install the logs and embers. See page 18.
7. Light the burner.
VFSE, see page 20. VFSV, see page 19.
8. Using the remote system.
VFSE, see pages 21-28, VFSV, see pages 29-30.
9. Troubleshooting.
Specific to VFSE, see pages 31-35. VFSV, see page 39.
10. Show the homeowner how to operate the burner.
VFSE, see pages 20, 21-28. VFSV, see pages 19, 29, and 30.
11. Cleaning and Servicing. See page 38.

TABLE OF CONTENTS

SECTION	PAGE
Before You Start	2
Important Safety Information	4
Safety Information for Users of Propane Gas	5
Introduction.....	6
Important Soot Prevention Steps	7
Product Specifications.....	8
Accessories	8
General Information.....	9
Water Vapor: A By-Product Of Unvented Room Heaters	9
Requirements for Canada	10
Provisions for Adequate Combustion & Ventilation Air	11
Clearances	12-13
Fireplace Preparation	14
Installing as a Vented Appliance.....	15
Before Fully Installing the Appliance	15
Combustible Material.....	16
Gas Supply.....	17
Placement of Glowing Embers and Lava Rock	18
Operation Instructions/Flame Appearance	18
VFSV-(16,18,24,30) Lighting Instructions.....	19
VFSE-(18,24,30) Lighting Instructions	20
VFSE Remote Electronic Ignition and Control System	21-28
VFSV Remote Control Instructions	29-30
Intermittant Troubleshooting.....	31-35
Pilot Flame Characteristics.....	36-37
Cleaning and Servicing	38
Troubleshooting.....	39
VFSE Parts List	40
VFSE Parts View	41
VFSV Parts List	42
VFSV Parts View	43
Appliance Service History	44-45
Master Parts Distributor List	46
How To Order Repair Parts	46
Warranty	47

IMPORTANT SAFETY INFORMATION

⚠ DANGER: Indicates a hazardous situation which, if not avoided, will result in death or serious injury.

⚠ WARNING: Indicates a hazardous situation which, if not avoided, could result in death or serious injury.

⚠ CAUTION: Indicates a hazardous situation which, if not avoided, could result in minor or moderate injury.

NOTICE: Addresses practices not related to personal injury.

- An unvented room heater having an input rating of more than 6,000 Btu per hour shall not be installed in a bathroom
- An unvented room heater having an input rating of more than 10,000 Btu per hour shall not be installed in a bedroom or bathroom.
- Due to high temperatures, the appliance should be located out of traffic and away from furniture and draperies.
- Children and adults should be alerted to the hazard of high surface temperature and should stay away to avoid burns or clothing ignition.
- Young children should be carefully supervised when they are in the same room with the appliance.
- Do not place clothing or other flammable material on or near the appliance.
- Avoid the use of scented air fresheners (plug in type air fresheners, etc.) while the log set is in operation. Air fresheners produce a residue in the air similar to candles and may produce a soot like substance.
- Avoid the use of scented or decorative candles while the log set is in operation. Candles produce a residue in the air that creates a soot like substance. Burning candles while the log set is operating magnifies the problem. It should be noted that candles, in general, produce soot. The amount of time burned and the quantity of candles burned will determine the amount of soot produced and deposited.
- Installation and repair should be done by a QUALIFIED SERVICE PERSON. This appliance should be inspected before use and at least annually by a professional service person. More frequent cleaning may be required due to excessive lint from carpeting, bedding materials, etc. It is imperative that control compartments, burners and circulating air passageways of the appliance be kept clean.
- DO NOT use this room heater if any part has been under water. Immediately call a qualified service technician to inspect the room heater and to replace any part of the control system and any gas control which has been under water.
- You must operate heater with fireplace screen in place.
- Do not place trash, logs or other articles on the log set during operation.
- During manufacturing, fabricating and shipping, various components of this appliance are treated with certain oils, films or bonding agents. These bonding agents are not harmful but may produce annoying smoke and smells as they are burned off during initial operation of the appliance. This is a normal temporary occurrence. A window should be opened during the initial bake out period.
- Correct installation of the ceramic fiber logs, proper location of the heater and annual cleaning are necessary to avoid potential problems with sooting. Sooting, resulting from improper installation or operation, can settle on surfaces outside the fireplace. See instructions for proper installation.
- **⚠ WARNING:** Do not allow fans to blow directly into the fireplace. Avoid any drafts that alter burner flame patterns.
- **⚠ WARNING:** Do not use a blower insert, heat exchanger insert or other accessory not approved for use with this heater.

• **⚠ WARNING!** This fireplace needs fresh air for ventilation to run properly. This fireplace has an ODS (oxygen depletion sensor) which will shut down the heater if adequate fresh air is not available. See troubleshooting section in the instructions.

• **⚠ WARNING:** DO NOT operate this appliance unless all components including logs, burners, and controls are in good working condition. Never operate this appliance if any log or twig is broken, or out of their intended position. Refer to the Log set placement instructions for correct log and twig positioning.

Replacement components are available through your local dealer as indicated in the How to Order Repair Parts section of the appliance manual.

• Keep appliance area clear and free from combustible materials, gasoline and other flammable vapors and liquids.

• **⚠ WARNING:** Failure to keep the primary air opening(s) of the burner(s) clean may result in sooting and property damage.

⚠ WARNING

When used without adequate combustion and ventilation air, heater may give off CARBON MONOXIDE, an odorless, poisonous gas.

Do not install heater until all necessary provisions are made for combustion and ventilation air. Consult the written instructions provided with the heater for information concerning combustion and ventilation air. In the absence of instructions, refer to the National Fuel Gas Code, ANSI Z223.1/NFPA 54, Air for Combustion and Ventilation, or applicable local codes.

This heater is equipped with a PILOT LIGHT SAFETY SYSTEM designed to turn off the heater if not enough fresh air is available.

DO NOT TAMPER WITH PILOT LIGHT SAFETY SYSTEM!

If heater shuts off, do not relight until you provide fresh air.

If heater keeps shutting off, have it serviced. Keep burner and control compartment clean.

CARBON MONOXIDE POISONING MAY LEAD TO DEATH.

Early signs of carbon monoxide poisoning resemble the flu, with headache, dizziness and/or nausea. If you have these signs, heater may not be working properly. Get fresh air at once! Have heater serviced.

Some people — pregnant women, persons with heart or lung disease, anemia, those under the influence of alcohol, those at high altitudes — are more affected by carbon monoxide than others.

The pilot light safety system senses the depletion of oxygen at its location. If this heater is installed in a structure having a high vertical dimension, the possibility exists that the oxygen supply at the higher levels will be less than that at the heater. In this type of application, a fan to circulate the structure air will minimize this effect. The use of this fan will also improve the comfort level in the structure. When a fan is used to circulate air, it should be located so that the air flow is not directed at the burner.

SAFETY INFORMATION FOR USERS OF PROPANE GAS

Propane is a flammable gas which can cause fires and explosions. In its natural state, propane is odorless and colorless. You may not know all the following safety precautions which can protect both you and your family from an accident. Read them carefully now, then review them point by point with the

members of your household. Someday when there may not be a minute to lose, everyone's safety will depend on knowing exactly what to do. If, after reading the following information, you feel you still need more information, please contact your gas supplier.

PROPANE GAS WARNING ODOR

If a gas leak happens, you should be able to smell the gas because of the odorant put in the Propane Gas. That's your signal to go into immediate action!

- Do not operate electric switches, light matches, use your phone. Do not do anything that could ignite the gas.
- Get everyone out of the building, vehicle, trailer, or area. Do that IMMEDIATELY.
- Close all gas tank or cylinder supply valves.
- Propane Gas is heavier than air and may settle in low areas such as basements. When you have reason to suspect a gas leak, keep out of basements and other low areas. Stay out until firefighters declare them to be safe.
- Use your neighbor's phone and call a trained Propane Gas service person and the fire department. Even though you may not continue to smell gas, do not turn on the gas again. Do not re-enter the building, vehicle, trailer, or area.
- **Finally**, let the service man and firefighters check for escaped gas. Have them air out the area before you return. Properly trained Propane Gas service people should repair the leak, then check and relight the gas appliance for you.

NO ODOR DETECTED - ODOR FADE

Some people cannot smell well. Some people cannot smell the odor of the chemical put into the gas. You must find out if you can smell the odorant in propane. Smoking can decrease your ability to smell. Being around an odor for a time can affect your sensitivity or ability to detect that odor. Sometimes other odors in the area mask the gas odor. People may not smell the gas odor or their minds are on something else. Thinking about smelling a gas odor can make it easier to smell.

The odorant in Propane Gas is colorless, and it can fade under some circumstances. For example, if there is an underground leak, the movement of the gas through soil can filter the odorant. Odorants in Propane Gas also are subject to oxidation. This fading

can occur if there is rust inside the storage tank or in iron gas pipes.

The odorant in escaped gas can adsorb or absorb onto or into walls, masonry and other materials and fabrics in a room. That will take some of the odorant out of the gas, reducing its odor intensity.

Propane Gas may stratify in a closed area, and the odor intensity could vary at different levels. Since it is heavier than air, there may be more odor at lower levels. Always be sensitive to the slightest gas odor. If you detect any odor, treat it as a serious leak. Immediately go into action as instructed earlier.

SOME POINTS TO REMEMBER

- **Learn to recognize the odor of Propane Gas.** Your local Propane Gas Dealer can give you a "Scratch and Sniff" pamphlet. Use it to find out what the propane odor smells like. If you suspect that your Propane Gas has a weak or abnormal odor, call your Propane Gas Dealer.
- If you are not qualified, do not light pilot lights, perform service, or make adjustments to appliances on the Propane Gas system. If you are qualified, consciously think about the odor of Propane Gas prior to and while lighting pilot lights or performing service or making adjustments.
- Sometimes a basement or a closed-up house has a musty smell that can cover up the Propane Gas odor. Do not try to light pilot lights, perform service, or make adjustments in an area where the conditions are such that you may not detect the odor if there has been a leak of Propane Gas.
- Odor fade, due to oxidation by rust or adsorption on walls of new cylinders and tanks, is possible. Therefore, people should be particularly alert and careful when new tanks or cylinders are placed in service. Odor fade can occur in new tanks, or reinstalled old tanks, if they are filled and allowed to set too long before refilling. Cylinders and tanks which have been out of service for a time may develop internal rust which will cause odor fade. If such conditions are suspected to exist, a periodic sniff test of the gas is advisable. **If you have any question about the gas odor, call your Propane Gas dealer. A periodic sniff test of the Propane Gas is a good safety measure under any condition.**
- If, at any time, you do not smell the Propane Gas odorant and you think you should, assume you have a leak. Then take the same immediate action recommended above for the occasion when you do detect the odorized Propane Gas.
- If you experience a complete "gas out," (the container is under no vapor pressure), turn the tank valve off immediately. If the container valve is left on, the container may draw in some air through openings such as pilot light orifices. If this occurs, some new internal rusting could occur. If the valve is left open, then treat the container as a new tank. Always be sure your container is under vapor pressure by turning it off at the container before it goes completely empty or having it refilled before it is completely empty.

INTRODUCTION

IMPORTANT: Read all instructions carefully before starting installation. Failure to follow these installation instructions may result in a possible fire hazard and will void the warranty.

Save this manual for future reference.

Please read this manual before installing and using the appliance.

Instructions to Installer

1. Installer must leave instruction manual with owner after installation.
2. Installer must have owner fill out and mail warranty card supplied with unvented room heater/vented decorative appliance.
3. Installer should show owner how to start and operate unvented room heater/vented decorative appliance.

Always consult your local Building Department regarding regulations, codes or ordinances which apply to the installation of an unvented room heater/vented decorative appliance.

This appliance may be installed in an aftermarket* manufactured (mobile) home, where not prohibited by state or local codes.

*Aftermarket: Completion of sale, not for purpose of resale, from the manufacturer.

Well Head Gas Installations

Some natural gas utilities use "well head" gas. This may affect the Btu output of the unit and promote sooting. Units shall not be converted to use well head gas.

This appliance is only for use with the type of gas indicated on the rating plate. This appliance is not convertible for use with other gases.

New Installation

Solid-fuels shall not be burned in a fireplace where a vented decorative appliance is installed.

A vented decorative appliance must be installed only in a solid-fuel burning fireplace with a working flue and constructed of noncombustible material.

Any alteration of the original design, installed other than as shown in these instructions or use with a type of gas not shown on the rating plate is the responsibility of the person and company making the change.

Important

All correspondence should refer to complete Model Number, Serial Number and type of gas.

Attention: During initial use of log you will detect an odor as the log is cured.

NOTICE: During initial firing of this unit, its paint will bake out, and smoke will occur. To prevent triggering of smoke alarms, ventilate the room in which the unit is installed.

WARNING

This appliance is for installation only in a solid-fuel burning masonry or UL 127 factory-built fireplace or in a listed ventless firebox enclosure. It has been design certified for these installations. Exception: DO NOT install this appliance in a factory-built fireplace that includes instructions stating it has not been tested or should not be used with unvented gas logs.

WARNING

Any modification to this unvented gas heater or its controls can be dangerous. Improper installation or use of the heater can cause serious injury or death from fire, burns, explosion or carbon monoxide poisoning.

IMPORTANT SOOT PREVENTION STEPS

▲ NOTICE IMPORTANT NOTICE ▲

INSTALLER - SERVICE PERSON - HOMEOWNER

SOOT MAY BE CREATED IF THE FOLLOWING DIRECTIONS ARE NOT FOLLOWED.

▲ WARNING

Failure to keep the primary air openings of the burner clean may result in sooting and property damage.

▲ WARNING

Before installing in a solid-fuel burning fireplace, the chimney flue and firebox must be cleaned of soot, creosote, ashes and loose paint by a qualified chimney cleaner.

- Check that the correct air shutter is installed. See table on Page 8.
- Ensure burner, venturi, and air shutter are free of dirt, lint, animal hair (i.e. cat and dog) or anything that may block the needed air flow. See Cleaning and Servicing, page 38.

▲ WARNING

Do not allow fans to blow directly into the fireplace. Avoid any drafts that alter burner flame patterns. Pay particular attention to ceiling fans and exhaust fans.

- Do not place debris, logs or other articles on burner.
- Avoid the use of scented air fresheners while the fireplace is in operation. A residue can be produced which may produce soot.
- Avoid the use of decorative or scented candles while the fireplace is in operation. Soot may be produced from the by-products of a burning candle. Some candles also produce soot.
- Do not place rock wool (embers) over the large ports of the burner.
- Do not place lava rocks on burner or burner ports. Lava rock is only to be placed on the fireplace floor.
- Check level of ceramic media in burner, if burner has ceramic media. Burner should be full, up to the ported burner surface.
- Install logs according to the installation instructions. Do not alter log placement from the prescribed layout. Only use Empire logs made for this burner.
- Annual inspection and cleaning by your dealer or qualified service technician is recommended to prevent malfunction and/or sooting.
- Verify the venturi tube is not bent or distorted. The main burner orifice must be centered in the venturi tube for proper combustion and to prevent sooting.

PRODUCT SPECIFICATIONS

	NATURAL GAS	
	VFSE	VFSV
Regulator Pressure Setting	3.5" W.C.	4.0" W.C.
Gas Inlet Pressure - Max.	10.5" W.C.	10.5" W.C.
Gas Inlet Pressure - Min.	7.0" W.C.	7.0" W.C.

	PROPANE GAS	
	VFSE	VFSV
Regulator Pressure Setting	10.0" W.C.	10.0" W.C.
Gas Inlet Pressure - Max.	13.0" W.C.	13.0" W.C.
Gas Inlet Pressure - Min.	11.0" W.C.	11.0" W.C.

NATURAL GAS MODELS

Model	Orifice	Gas	Air Shutter Opening	Color	Valve Type	BTUH Max. Rate	BTUH Min. Rate
VFSE-18	#36	Natural	1/8"	Blue	Intermittent	32,000	26,000
VFSE-24	#33	Natural	1/16"	Purple	Intermittent	36,000	28,800
VFSE-30	#32	Natural	1/16"	Purple	Intermittent	38,000	30,000
VFSV-16	#42	Natural	1/16"	Purple	Variable	25,000	18,000
VFSV-18	#36	Natural	1/8"	Blue	Variable	32,000	21,000
VFSV-24	#32	Natural	1/16"	Purple	Variable	36,000	24,000
VFSV-30	#31	Natural	1/16"	Purple	Variable	38,000	27,000

PROPANE GAS MODELS

Model	Orifice	Gas	Air Shutter Opening	Valve Type	BTUH Max. Rate	BTUH Min. Rate
VFSE-18	1.65mm	Propane	Full Open	Intermittent	32,000	26,000
VFSE-24	#50	Propane	Full Open	Intermittent	36,000	28,800
VFSE-30	#49	Propane	Full Open	Intermittent	38,000	30,000
VFSV-16	1.40mm	Propane	Full Open	Variable	22,500	17,000
VFSV-18	#51	Propane	Full Open	Variable	32,000	21,000
VFSV-24	1.80mm	Propane	Full Open	Variable	36,000	24,000
VFSV-30	#49	Propane	Full Open	Variable	38,000	27,000

NOTICE: Thermostats are for Vent-Free Applications only.

ACCESSORIES

FOR USE WITH VFSE AND VFSV MODELS

Accessory	Description	Color
EK-1	Embers Kit	
ELH-1	Fireplace Hood for Vent-Free Logs	Black

FOR USE WITH VFSE MODELS ONLY

AD1106V	AC/DC Adapter
---------	---------------

NOTICE: Thermostats are for Vent-Free Applications only.

NOTICE: For vented applications of VFSE models, an FRIP (non-thermostat) remote must be used.

GENERAL INFORMATION

This is an unvented gas-fired heater. It uses air (oxygen) from the room in which it is installed. Provisions for adequate combustion and ventilation air must be provided.

Keep room area clear and free from combustible materials, gasoline and other flammable vapors and liquids.

Unvented gas heaters are a supplemental zone heater. They are not intended to be a primary heating appliance. Water vapor produced by an unvented heater can create moisture problems in a home when operated for extended periods of time.

During manufacturing, fabricating and shipping, various components of this appliance are treated with certain oils, films or bonding agents. These chemicals are not harmful but may produce annoying smoke and smells as they are burned off during the initial operation of the appliance; possibly causing headaches or eye or lung irritation. This is a normal and temporary occurrence.

The initial break-in operation should last 2 to 3 hours with the burner at the highest setting. Provide maximum ventilation by opening windows or doors to allow odors to dissipate. Any odors remaining after this initial break-in period will be slight and will disappear with continued use.

This appliance must not be used with glass doors in the closed position. This can lead to pilot outages and severe sooting outside the fireplace.

Do not use this room heater if any part has been under water. Immediately call a qualified service technician to inspect the room heater and replace any part of the control system and any gas control which has been under water.

WARNING

This appliance is equipped for (natural or propane) gas. Field conversion is not permitted.

Before you get started

Carefully inspect the contents for shipping damage. If any parts are missing or damaged, immediately inform the dealer from whom you purchased the appliance. Do not attempt to install any part of the appliance unless you have all parts in good condition.

Make sure you have received all parts:

Check your packing list to verify that all listed parts have been received. You should have the following:

- Gas log grate/burner assembly.
- Two (2) masonry anchoring screws and two (2) 10 x 1/2" black sheet metal anchoring screws.
- Plastic bag containing glowing embers (rock wool) for burner coverage.
- Plastic bag containing lava rock.
- Remote Kit

Handle the gas log burner assembly by the grate and legs only. Do not pick the unit up by the burner.

Gloves are recommended when handling logs to prevent skin irritation. Logs are fragile - Handle with care.

Qualified Installing Agency

Installation and replacement of gas piping, gas utilization equipment or accessories and repair and servicing of equipment shall be performed only by a qualified agency. The term "qualified agency" means any individual, firm, corporation, or company that either in person or through a representative is engaged in and is responsible for (a) the installation, testing, or replacement of gas piping or (b) the connection, installation, testing, repair, or servicing of equipment; that is experienced in such work; that is familiar with all precautions required, and that has complied with all the requirements of the authority having jurisdiction.

Commonwealth of Massachusetts: The installation must be made by a licensed plumber or gas fitter in the Commonwealth of Massachusetts.

Sellers of unvented propane or natural gas-fired supplemental room heaters shall provide to each purchaser a copy of 527 CMR-30 upon sale of the unit.

The installation must conform with local codes or, in the absence of local codes, with the National Fuel Gas Code, ANSI Z223.1.*

**Available from the American National Standards Institute, Inc. 11 West 42nd St., New York, N.Y. 10018.*

High Altitudes: For altitudes/elevation above 2,000 feet ratings should be reduced at the rate of 4 percent for each 1,000 feet above sea level. Contact the manufacturer.

WATER VAPOR: A BY-PRODUCT OF UNVENTED ROOM HEATERS

Water vapor is a by-product of gas combustion. An unvented room heater produces approximately one (1) ounce (30ml) of water for every 1,000 BTU's (.3KW's) of gas input per hour.

Unvented room heaters must be used as supplemental heat (a room) rather than a primary heat source (an entire house). In most supplemental heat applications, the water vapor does not create a problem. In most applications, the water vapor enhances the low humidity atmosphere experienced during cold weather.

The following steps will help insure that water vapor does not become a problem.

1. Be sure the heater is sized properly for the application, including ample combustion air and circulation air.
2. If high humidity is experienced, a dehumidifier may be used to help lower the water vapor content of the air.
3. Do not use an unvented room heater as the primary heat source (an entire house).

REQUIREMENTS FOR CANADA

This unit **cannot** be installed in a UNVENTED application, this unit **can only** be installed as a VENTED application with these requirements.

IMPORTANT SAFETY INFORMATION

This unit complies with ANSI Z21.60 and CGA 2.26 Decorative Gas Appliances For Installation In Solid Fuel Burning Fireplaces. Do not burn wood or solid fuels in a fireplace where a decorative gas log set is installed. This appliance is for installation only in a solid fuel burning fireplace, masonry fireplace or manufactured fireplace.

WARNING: Any modification to this gas log set or to controls can be dangerous. Improper installation or use of the gas log set can cause serious injury or death from fire, burns, explosion or carbon monoxide poisoning.

1. Please follow all local codes regarding installation, combustion and ventilation air or in the absence of local codes follow the National Fuel Gas Code ANSI Z223.1(U.S. installation), or CAN/CGA-B149, Installation Code (Canada installation).
2. Proper installation, burner pan location and log placement is important to achieve optimum look and performance of your gas log set. The logs have been designed for easy location and placement on the grate and must be followed for proper operation.
3. Do not operate this log set with glass doors in the closed position. A fireplace screen must be in place when the log set is burning. Adequate combustion air must be provided for proper venting. All flames should go up and out the top of the firebox into the flue vent. If any flames float or curl forward into the room do not operate appliance. Check for an open flue and adequate combustion air into the room. A damper clamp must be installed on the firebox damper to maintain an open flue vent condition. Refer to page 11 INSTALLING DAMPER CLAMP
4. Young children must be carefully supervised when they are in the same room as the gas log while in operation. Do not place stockings, clothing or any flammable material above or near the fireplace.
5. Do not substitute or use materials other than those supplied for use with the log set.
6. Also refer to IMPORTANT SAFETY INFORMATION on page 41 of this manual

WARNING; DO NOT OPERATE THIS GAS LOG SET WITH GLASS DOORS CLOSED

- Clothing or other flammable material should not be placed on or near the appliance.
- **Do not** place trash or other articles on the log set during operation.
- During manufacturing, fabricating and shipping, various components of this appliance are treated with certain oils, films or bonding agents. These bonding agents are not harmful but may produce annoying smoke and smells as they are burned off during initial operation of the appliance. This is a normal temporary occurrence. A window should be opened during the initial bake out period.
- Keep burner and control compartment clean.
- **WARNING:** Before installing in a solid fuel burning fireplace, the chimney flue and firebox must be cleaned of soot, creosote, ashes and loose paint by a qualified chimney cleaner.
- Installation and repair should be done by a qualified service person. The appliance should be inspected before use and at least annually by a qualified service person. More frequent cleaning may be required due to excessive lint from carpeting, bedding materials, etc. It is imperative that control compartments, burners and circulating air passageways of the appliance be kept clean.
- **Do not** put anything around the fireplace that will obstruct the flow of ventilation air.
- **Do** keep the appliance area clear and free from combustible material, gasoline and other flammable vapors and liquids.
- A yearly examination and cleaning of the venting system of the solid-fuel burning fireplace must be performed by a qualified agency.
- **Do** make a periodic visual check of pilot and burners. Clean and replace damaged parts.
- **Do not** use this appliance if any part has been under water. Immediately call a qualified service technician to inspect the appliance and to replace any part of the control system and any gas control which has been under water.
- Never burn solid fuels in fireplace where a gas log set is installed.
- This unit complies with ANSI Z21.60 Decorative Vented Appliances for Solid Fuel Burning Fireplaces. State or local codes may only allow operation of this appliance in a vented configuration. Check your state or local codes.

PROVISIONS FOR ADEQUATE COMBUSTION & VENTILATION AIR

This heater shall not be installed in a confined space unless provisions are provided for adequate combustion and ventilation air.

A confined space is an area with volume less than 50 cubic feet per 1,000 Btuh of the combined input rates of all appliances drawing combustion air from that space. Small areas such as equipment rooms are confined spaces. Furnaces installed in a confined space which supply heated air to areas outside the space must draw return air from outside the space through tightly sealed return air ducts. A confined space must have 2 openings into the space for combustion air. One opening must be within 12 inches of the ceiling and the other must be within 12 inches of the floor. The required sizing of these openings is determined by whether inside or outside air is used to support combustion, the method by which the air is brought to the space (vertical or horizontal duct) and by the total input rate of all appliances in the space.

UNUSUALLY TIGHT CONSTRUCTION

The air that leaks around doors and windows may provide enough fresh air for combustion and ventilation. However, in buildings of unusually tight construction, you must provide additional fresh air.

Unusually tight construction is defined as construction where:

- Walls and ceilings exposed to the outside atmosphere have a continuous water vapor retarder with a rating of one perm or less with openings gasketed or sealed, and
- Weatherstripping has been added on openable windows and doors, and
- Caulking or sealants are applied to areas such as joints around window and door frames, between sole plates and floors, between wall-ceiling joints, between wall panels, at penetrations for plumbing, electrical, and gas lines, and at other openings.

If your home meets all of the three criteria above, you must provide additional fresh air.

WARNING

If the area in which the heater may be operated is smaller than that defined as an unconfined space or if the building is of unusually tight construction, provide adequate combustion and ventilation air by one of the methods described in the National Fuel Gas Code, ANSI Z223.1/NFPA 54, Air for Combustion and Ventilation, or applicable local codes.

Example of Large Room with 1/2 Wall divider.

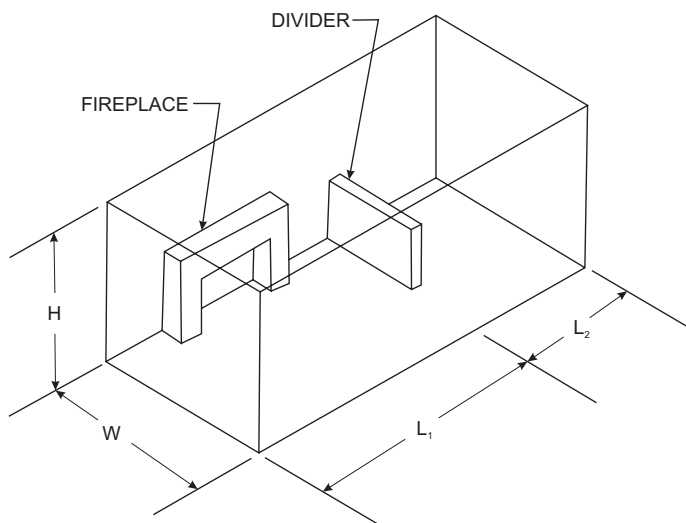

Figure 1

The following formula can be used to determine the maximum heater rating per the definition of unconfined space:

$$Btu/Hr = \frac{(L_1 + L_2)FT \times (W)FT \times (H)FT}{50} \times 1000$$

If the area in which the heater may be operated is smaller than that defined as an unconfined space, provide adequate combustion and ventilation air by one of the methods described in the National Fuel Gas Code, ANSI Z223.1, NFPA54.

Adhere to all codes, or in their absence, the latest edition of THE NATIONAL FUEL GAS CODE ANSI Z223.1/NFPA54 which can be obtained from:

American National Standards Institute National Fire Protection Association, Inc.

11 West 42nd St.
New York, NY 10018

Batterymarch Park
Quincy, MA 02269

CLEARANCES

Minimum Dimensions For Solid Fuel Burning Fireplaces UL127 Factory Built Fireplaces (Figure 2)

Model	A	B	C	D
VFSE-18	17"	14"	28"	17"
VFSE-24	23"	14"	30"	18"
VFSE-30	26"	14"	34"	20"
VFSV-16	18"	11 1/2"	24"	18"
VFSV-18	17"	14"	28"	17"
VFSV-24	23"	14"	30"	18"
VFSV-30	26"	14"	34"	20"

The dimensions shown and defined in the fireplace manufacturer's instructions are minimum clearances to maintain in installing this heater. Left and right clearances are determined when facing the front of the heater.

GLASS DOORS

Make sure that glass doors are open during all operations of the logset. The opening of the glass door frame should be the dimension used for the minimum front opening of the firebox.

Follow these instructions to ensure safe installation. Failure to follow instructions exactly can create a fire hazard.

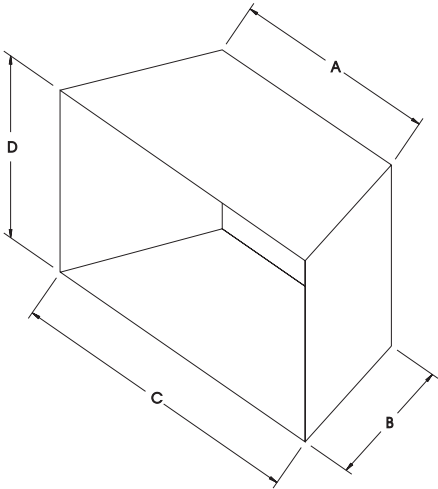

Figure 2

Sidewall & Ceiling Clearances

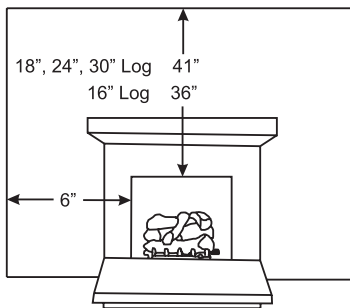

Figure 3

The sides of the fireplace opening must be 6" from any combustible wall. The ceiling must be at least 36" (for the 16" log) and 41" (for 18", 24" and 30" logs) from the fireplace opening.

MANTEL CLEARANCES WITHOUT HOOD

You must have non-combustible materials above the fireplace opening. Non-combustible material must extend at least 12" above fireplace opening. With sheet metal, you must have non-combustible material behind it.

Non-combustible materials such as slate and marble must be at least 1/2" thick. Sheet metal should not be installed onto combustible material.

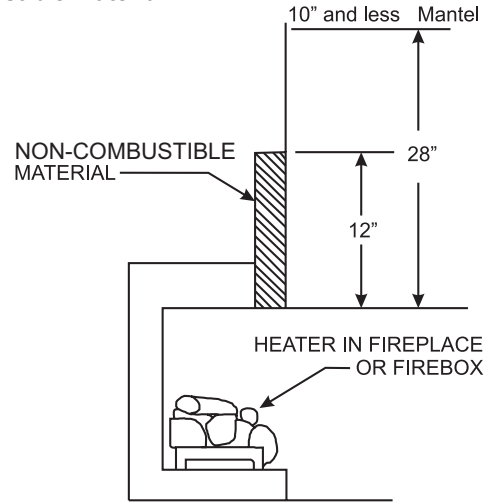

Figure 4

If your installation does not meet the above clearances, you must proceed to one of the following steps:

- Use a hood
- Operate the heater with flue damper open. See page 15 for **Installing as a Vented Appliance.**
- Raise the mantel to the proper height.
- Remove the mantel.

Non-Combustible Material Distance	Requirements For Safe Installation
12" or more	Non-combustible material
Less than 12"	Non-combustible material must be extended to at least 8" with the installation of the optional fireplace hood. If you cannot extend non-combustible material at least 8", you must operate heater with flue damper open.

CLEARANCES (CONT'D)

Mantel Clearances with Hood

You must have non-combustible materials above the fireplace opening. Non-combustible material must extend at least 8" above fireplace opening. With sheet metal, you must have non-combustible material behind it.

Non-combustible materials such as slate and marble must be at least 1/2" thick. Sheet metal should not be installed onto combustible material.

Example: A mantel may project from the wall a maximum of 2" at a minimum of 8" above the opening, and a maximum of 6" at a minimum of 15" above the opening.

NOTICE: If floor is sunken below the opening, the unit needs to be raised above the hearth level or the opening of the glass door surround.

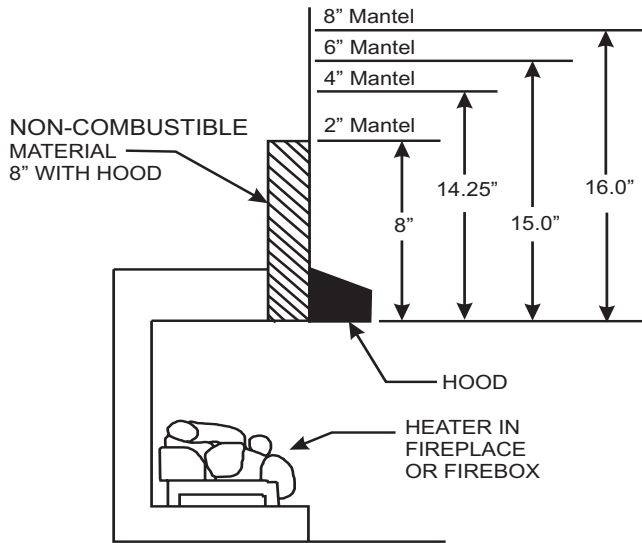

Figure 5

If your installation does not meet the above minimum clearances, you must proceed to one of the following steps:

- Operate the heater with the flue damper open. See page 15 for **Installing as a Vented Appliance**.
- Raise the mantel to the proper height.
- Remove the mantel.

Floor Clearance

If installing heater at floor level, the minimum distance to combustibles is "0" inches.

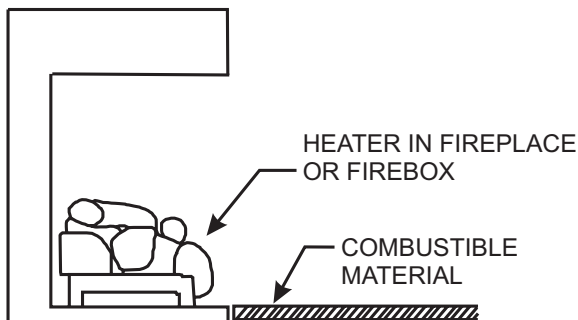

Figure 6

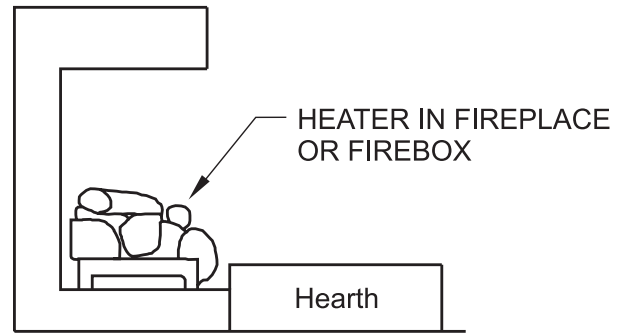

Figure 6a

FIREPLACE PREPARATION

- Turn off gas supply to fireplace or firebox.
- Have the fireplace floor and chimney professionally cleaned to remove ashes, soot, creosote or other obstructions. Have this cleaning performed annually after installation.
- Seal any fresh air vents or ash clean-out doors located on floor or wall of fireplace. If not, drafting may cause pilot outage or sooting. Use a heat-resistant sealant. Do not seal chimney flue damper.

Install and operate the appliance as directed in this manual.

FOR FACTORY BUILT FIREPLACES FREE OPENING AREA OF CHIMNEY DAMPER FOR VENTING COMBUSTION PRODUCTS FROM DECORATIVE APPLIANCES FOR INSTALLATION IN SOLID FUEL BURNING FIREPLACES

Chimney Height* (ft)	Appliance Input Rate (BTU/hr)		
	20	30	40
	Minimum Opening** (sq. in.)		
10	11.3	16.6	22.1
15	8.6	12.6	17.3
20	7.5	10.8	14.5
25	6.6	9.6	12.6
30	6.2	9.1	11.3
35	5.7	8.0	10.8
40	5.3	7.5	10.2

* Height is from hearth to top of chimney and the minimum height is 10 feet.

** Chart shows minimum opening (sq. in.) for given height and input rate.

FOR MASONRY BUILT FIREPLACES FREE OPENING AREA OF CHIMNEY DAMPER FOR VENTING COMBUSTION PRODUCTS FROM DECORATIVE APPLIANCES FOR INSTALLATION IN SOLID FUEL BURNING FIREPLACES

Chimney Height* (ft)	Appliance Input Rate (BTU/hr)		
	20	30	40
	Minimum Opening** (sq. in.)		
6	17.6	25.7	33.8
8	16.5	23.7	31.2
10	15.1	21.7	28.7
15	14.1	19.9	26.1
20	12.9	18.5	23.7
30	12.2	16.9	21.6

* Height is from hearth to top of chimney and the minimum height is 6 feet.

** Chart shows minimum opening (sq. in.) for given height and input rate.

INSTALLING AS A VENTED APPLIANCE

NOTICE: (Damper Clamp Installation)

When installing your log set as a vented installation the damper clamp must be used.

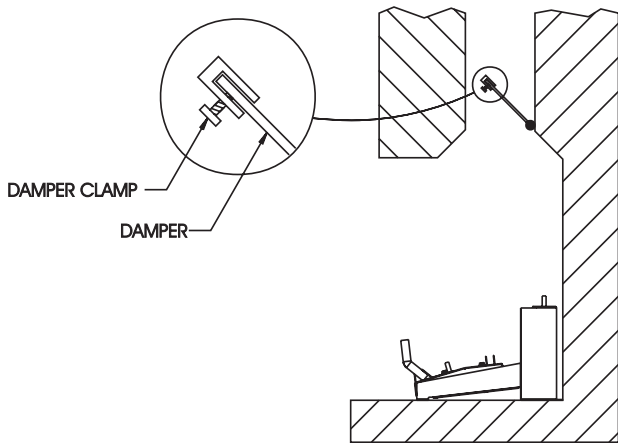

TYPICAL FIREPLACE
Figure 7

When installing your log set as a vent-free installation the damper clamp can be used to eliminate the potential for odors when burning the logs for the first time.

Installing Damper Clamp

Remove all ashes or other debris from the fireplace. If the fireplace is equipped with an ash dump be sure to seal the door with furnace cement or high temperature silicone. Be sure to check the damper for proper operation and verify that the flue passageway is open.

Place the clamp over the lip of the damper and tighten the hold down bolt until the clamp is securely attached to the damper. This will prevent the damper from accidentally closing.

Manual and millivolt controlled gas logs may be installed as a vented decorative log set in compliance with ANSI Z21.60 and National Fuel Gas Code. When the gas logs are operated with the damper open, noncombustible material and minimum mantel requirements do not apply.

BEFORE FULLY INSTALLING THE APPLIANCE

- Turn off the gas supply to the fireplace or firebox.
- Seal any fresh air vents and/or ash clean-out doors located on the floor or wall of the fireplace. If left unsealed, drafting may cause pilot outage or sooting. Use a heat resistant sealant. Do not seal the chimney flue damper.

Before installing in a solid fuel burning fireplace, the chimney flue and firebox must be cleaned of soot, creosote, ashes and loose paint by a qualified chimney cleaner.

You must secure the gas log heater to the fireplace floor. If not, the entire unit may move when you adjust the controls. Movement of unit may cause shifting of the gas logs which leads to sooting and improper burning. Grate movement could cause a gas leak.

Special care is required if you are installing the unit into a sunken fireplace. You must raise the fireplace floor to allow access to gas log controls. This will insure adequate air flow and guard against sooting. Raise the fireplace floor using noncombustible materials.

Assembly Procedure:

1. Center the gas log unit in the fireplace or firebox. Make certain the front feet of the grate sit inside the front edge of the fireplace or firebox.
2. An anchor hole is provided in the two bottom side members of the grate frame. After centering the grate correctly, mark the hole positions on the fireplace/firebox floor. Drill two (2) 5/32" diameter holes approximately 1 1/2" deep for masonry screws or 1/8" hole for sheet metal screws.
3. Anchor the grate to the fireplace/firebox floor using the screws provided. **Refer to Figure 8.**

Proper installation of the grate is essential to prevent any movement of the gas logs and controls during operation.

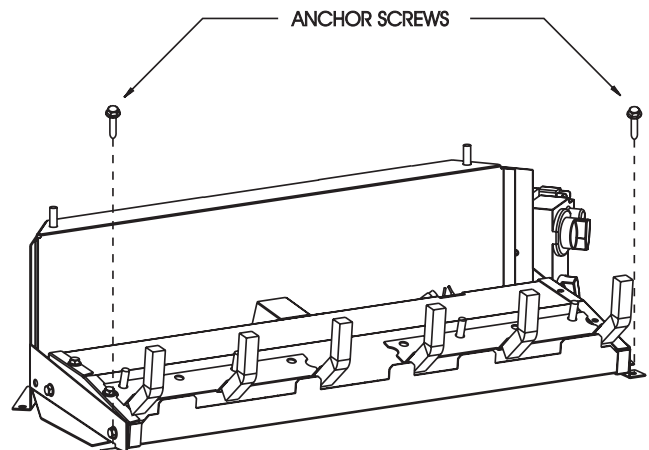

Figure 8

COMBUSTIBLE MATERIAL

Do not attach combustible material to the mantel of your fireplace. This is a fire hazard.

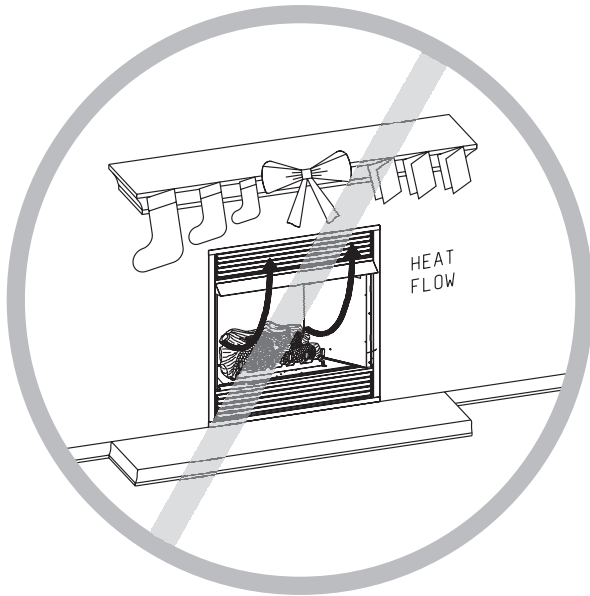

Figure 9

No greeting card, stockings or ornamentation of any type should be placed on or attached to the fireplace. This is a heating appliance. The flow of heat can ignite combustibles.

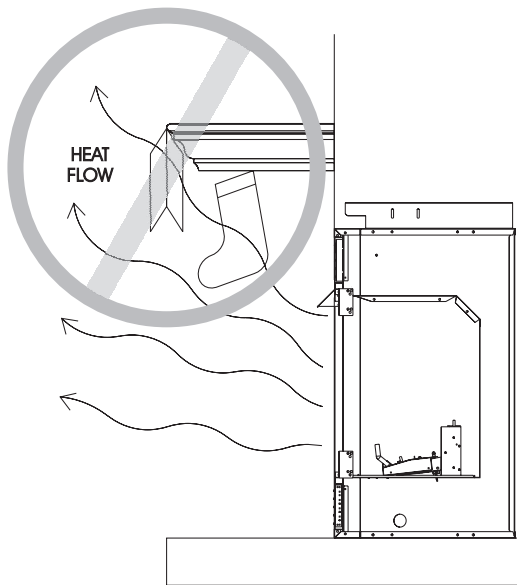

Figure 10

Television Considerations

Installing a television above a fireplace has become a desirable feature; however, the following information should be considered. All fireplaces, whether decorative or heater rated create heat. Most television manufacturers recommend not placing a television near a heat source. Because there is a large variety of television manufactures, styles and sizes, it is impractical to test every potential installation. If you choose to install a television above or near your fireplace, understand that Empire Comfort Systems accepts no responsibility for this decision and any injury or damage due to this application is the sole responsibility of the owner. Additionally, it is highly recommended to turn off the fireplace and let it cool down before servicing or using the operational buttons located on the television. In all cases, the television manufacturer's instructions and warnings should be followed.

GAS SUPPLY

Check all local codes for requirements, especially for the size and type of gas supply line required.

RECOMMENDED GAS PIPE DIAMETER				
Pipe Length	Schedule 40 Pipe Inside Diameter		Tubing, Type L Outside Diameter	
	Natural	Propane	Natural	Propane
0-10 feet 0-3 meters	1/2" 12.7mm	3/8" 9.5mm	1/2" 12.7mm	3/8" 9.5mm
10-40 feet 4-12 meters	1/2" 12.7mm	1/2" 12.7mm	5/8" 15.9mm	1/2" 12.7mm
40-100 feet 13-30 meters	1/2" 12.7mm	1/2" 12.7mm	3/4" 19mm	1/2" 12.7mm
100-150 feet 31-46 meters	3/4" 19mm	1/2" 12.7mm	7/8" 22.2mm	3/4" 19mm

NOTICE: Never use plastic pipe. Check to confirm whether your local codes allow copper tubing or galvanized.

NOTICE: Since some municipalities have additional local codes, it is always best to consult your local authority and installation code.

Installing a New Main Gas Shut-Off

Each appliance should have its own manual gas shut-off.

A manual main gas shut-off should be located in the vicinity of the unit. Where none exists, or where its size or location is not adequate, contact your local authorized installer for installation or relocation.

Compounds used on threaded joints of gas piping shall be resistant to the action of liquefied petroleum gases. The gas lines must be checked for leaks by the installer. This should be done with a soap solution watching for bubbles on all exposed connections, and if unexposed, a pressure test should be made.

NOTICE: Check inlet and outlet fittings on gas valve for leaks, but do not expose electronic components to the solution. Exposing them to the solution may damage the components.

Never use an exposed flame to check for leaks. Appliance must be disconnected from piping at inlet of control valve and pipe capped or plugged for pressure test. Never pressure test with appliance connected; control valve will sustain damage!

A gas valve and ground joint union should be installed in the gas line upstream of the gas control to aid in servicing. It is required by the National Fuel Gas Code that a drip line be installed near the gas inlet. This should consist of a vertical length of pipe tee connected into the gas line that is capped on the bottom in which condensation and foreign particles may collect.

FLEXIBLE GAS LINE CONNECTION

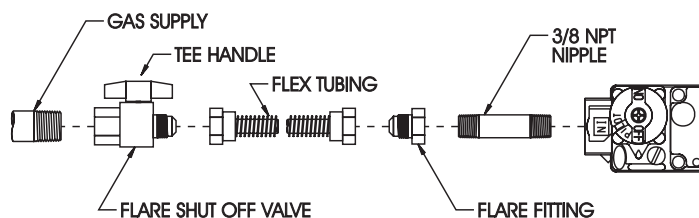

RIGID GAS LINE CONNECTION

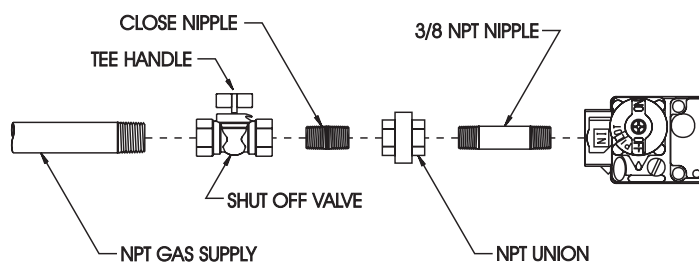

Figure 11

The use of the following gas connectors is recommended:

- ANS Z21.24 Appliance Connectors of Corrugated Metal Tubing and Fittings
- ANS Z21.45 Assembled Flexible Appliance Connectors of Other Than All-Metal Construction

The above connectors may be used if acceptable by the authority having jurisdiction. The Commonwealth of Massachusetts requires that a flexible appliance connector cannot exceed three feet in length.

Pressure Testing of the Gas Supply System

1. To check the inlet pressure to the gas valve, a 1/8" (3.175mm) N.P.T. plugged tapping, accessible for test gauge connection, must be placed immediately upstream of the gas supply connection to the appliance.
2. The appliance and its individual shutoff valve must be disconnected from the gas supply piping system during any pressure testing of that system at test pressures in excess of 1/2 psig (3.5 kPa).
3. The appliance must be isolated from the gas supply piping system by closing its individual manual shutoff valve during any pressure testing of the gas supply piping system at test pressures equal to or less than 1/2 psig (3.5 kPa).

Attention! If one of the procedures results in pressures in excess of 1/2 psig (14" w.c.) (3.5 kPa) on the appliance gas valve, it will result in a hazardous condition.

PLACEMENT OF GLOWING EMBERS AND LAVA ROCK

Placement of the glowing embers (rock wool) is very individual and light coverage will provide your best effects. We recommend separation of the rock wool by hand and make your coverage as light and fluffy as possible.

Place just enough embers on the burner to obtain the glow and a gold, yellow flame.

Do not place embers (rock wool) over large ports in rear portion of burner.

Rock wool should not be placed in the area of the pilot assembly.

Replacement of loose material (glowing embers) must be purchased from Empire Comfort Systems, Inc. Application of excess loose material (glowing embers) may adversely affect performance of the heater. **WARNING:** All previously applied loose material must be removed prior to reapplication.

Refer to Parts List, Pages 40 and 42 to order loose material (rock wool).

Placing Lava Rock in Front of Burner on Fireplace Floor

Spread lava rocks on fireplace floor in front of the burner pan. The lava rocks are for decorative effect and are not required for fireplace operation.

ATTENTION: Do not place lava rocks on burner, logs or rock wool. The lava rocks should only be placed on the fireplace floor.

NOTICE: Refer to log instruction manual for log placement.

OPERATION INSTRUCTIONS/FLAME APPEARANCE

Flames from the pilot (rear right back side of the pan burner) as well as the main flame should be visually checked as the log set is installed.

In normal operation at full rate after 10 to 15 minutes, the flame appearance should be sets of yellow flames.

NOTICE: All flames will be random by design, flame height will go up and down.

Glowing embers (rock wool) can cover the pan burner in between the front and middle logs, but very little is necessary to cover this area. Excess ember material causes the yellow flame to become orange and stringy. Apply just enough to obtain slow glow and a gold yellow flame.

Avoid any drafts that alter burner flame patterns. Do not allow fans to blow directly into fireplace. Do not place a blower inside the burner area of the firebox. Ceiling fans may create drafts that alter flame patterns. Sooting and improper burning will result.

During manufacturing, fabricating and shipping, various components of this appliance are treated with certain oils, films or bonding agents. These chemicals are not harmful, but may produce annoying smoke and smells as they are burned off during the initial operation of the appliance, possibly causing headaches or eye or lung irritation. This is a normal and temporary occurrence.

The initial break-in operation should last 2 to 3 hours with the burner at the highest setting. Provide maximum ventilation by opening windows or doors to allow odors to dissipate. Any odors remaining after this initial break-in will be slight and will disappear with continued use.

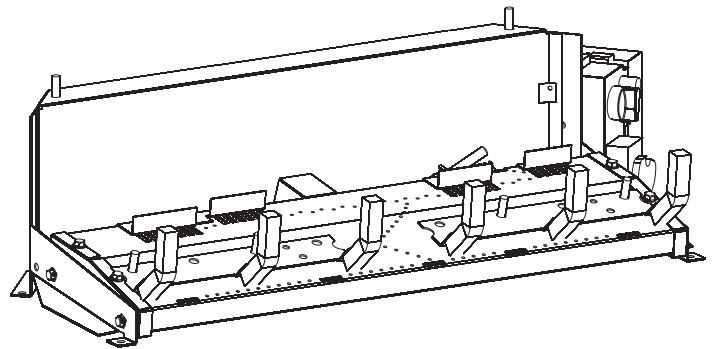

Intermittent - Figure 12

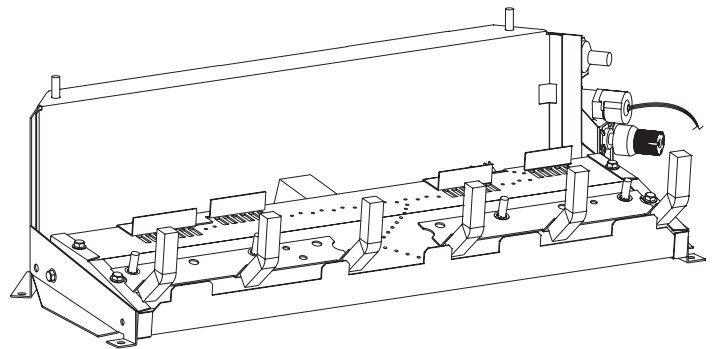

Variable - Figure 13

VFSV-(16,18,24,30) LIGHTING INSTRUCTIONS

FOR YOUR SAFETY READ BEFORE LIGHTING

⚠ WARNING

If you do not follow these instructions exactly, a fire or explosion may result causing property damage, personal injury or loss of life.

- A. This appliance has a pilot which must be lighted by hand. When lighting the pilot, follow these instructions exactly.
- B. **BEFORE LIGHTING** smell all around the appliance area for gas. Be sure to smell next to the floor because some gas is heavier than air and will settle on the floor.
- WHAT TO DO IF YOU SMELL GAS**
- Do not try to light any appliance.
 - Do not touch any electrical switch; do not use any phone in your building.
 - Immediately call your gas supplier from a neighbor's phone. Follow the gas supplier's instructions.
 - If you cannot reach your gas supplier, call the fire department.
- C. Use only your hand to push in or turn the gas control knob. Never use tools. If the knob will not push in or turn by hand, don't try to repair it; call a qualified service technician. Force or attempted repair may result in a fire or explosion.
- D. Do not use this appliance if any part has been under water. Immediately call a qualified service technician to inspect the appliance and to replace any part of the control system and any gas control which has been under water.

LIGHTING INSTRUCTIONS

1. STOP! Read the safety information on this page.
2. Push in gas control knob slightly and turn clockwise to "OFF." Do not force.
3. Turn gas flow adjustment knob clockwise either manually or with remote control to "OFF."
4. Wait ten (10) minutes to clear out any gas. Then smell for gas, including near floor. If you smell gas, STOP! Follow "B" in the safety information above. If you do not smell gas, go to the next step.
5. Find pilot - follow metal tube from gas control. The pilot is behind the second log on the right side.
6. Turn gas control knob counterclockwise to "PILOT."

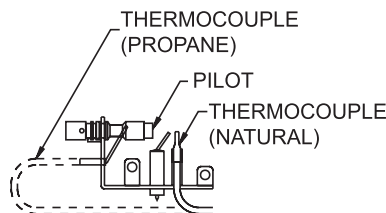
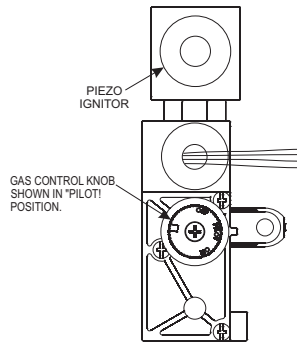

7. Push in control knob all the way and hold in. Immediately light the pilot with the piezo pilot ignitor or use a match. Continue to hold the control knob in for about one (1) minute after the pilot is lit. Release knob, and it will pop back up. Pilot should remain lit. If it goes out, repeat steps 5 through 8. If knob does not pop up when released, stop and immediately call a qualified service technician or gas supplier. If the pilot will not stay lit after several tries, turn the gas control knob to "OFF" and call your service technician or gas supplier.
8. Turn gas control knob counterclockwise to on.
9. Turn on all electric power to the appliance (if applicable).

TO TURN OFF GAS TO APPLIANCE

1. Turn gas flow adjustment knob clockwise either manually or with remote control to "OFF".
2. Push in gas control knob slightly and turn clockwise to "OFF". Do not force.

VFSE-(18,24,30) LIGHTING INSTRUCTIONS

FOR YOUR SAFETY READ BEFORE LIGHTING

⚠ WARNING

If you do not follow these instructions exactly, a fire or explosion may result causing property damage, personal injury or loss of life.

- A. BEFORE LIGHTING smell all around the appliance area for gas. Be sure to smell next to the floor because some gas is heavier than air and will settle on the floor.
- WHAT TO DO IF YOU SMELL GAS**
- Do not try to light any appliance.
 - Do not touch any electrical switch.
 - Do not use any phone in your building.
 - Immediately call your gas supplier from a neighbor's phone. Follow the gas supplier's instructions.
 - If you can not reach your gas supplier, call the fire department.
- B. Use only your hand to push in or turn the gas control knob. Never use tools. If the knob will not push in or turn by hand, don't try to repair it, call a qualified service technician. Force or attempted repair may result in a fire or explosion.
- C. Do not use this appliance if any part has been under water. Immediately call a qualified service technician to inspect the appliance and to replace any part of the control system and any gas control which has been under water.



LIGHTING INSTRUCTIONS

1. STOP! Read the safety information above on this page.
2. Open bottom louver assembly, (if applicable).
3. Press the "I/O" (ON/OFF) button on the valve to face to "O" (OFF).
4. Wait five (5) minutes to clear out any gas, then smell for gas including near the floor. If you smell gas, STOP! Follow "A" in the safety information above. If you don't smell gas, go to the next step.

LIGHTING PROCEDURE - HANDSET METHOD

1. Turn control arrow on valve face to "ON." Press the "I/O" button to "I". Press the "OFF" and "UP" buttons on the handset firmly at the same time. A long "beep" will sound, followed by 5 short "beeps". Ignitor will spark and will continue until pilot is lit. For full Remote Control operation see appliance installation manual.

LIGHTING PROCEDURE - MANUAL METHOD

1. Press the "I/O" (ON/OFF) button to "I" for on.
2. Turn control arrow on valve face to "MAN" for manual.
3. Change the ignition cable from the receiver to the valve (Piezo Ignition tab).
4. Using a small bladed screwdriver, press & hold button within hole on control. Manually depress piezo igniter button to light the pilot. If pilot does not light, step 4 can be immediately repeated. If the pilot will not stay lit after several tries, follow the instructions "To Turn Off Gas to Appliance" and call your service technician or gas supplier.
5. When the pilot is lit and stable, turn the valve control knob counterclockwise  to the "ON" position. Turn flame height control knob counterclockwise  and the main burner will ignite. Turn flame height control knob to adjust flame height.

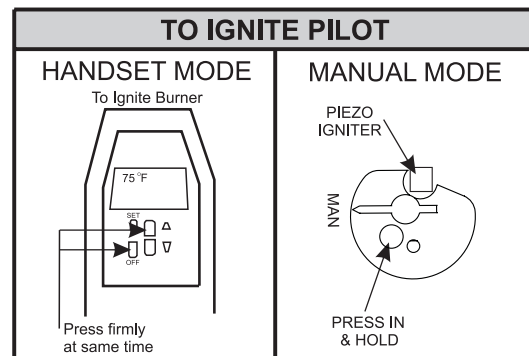
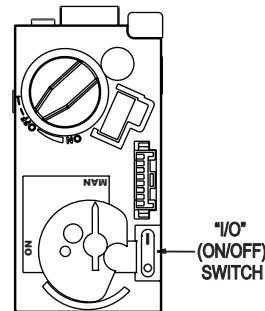

TO TURN OFF GAS TO THE APPLIANCE

MANUAL MODE - To turn off main burner, turn flame height control knob fully clockwise . To fully shut down, press "I/O" button to "O".

HANDSET MODE - Press "OFF" button on handset. To fully shut down, press "I/O" button to "O".

VFSE REMOTE ELECTRONIC IGNITION AND CONTROL SYSTEM

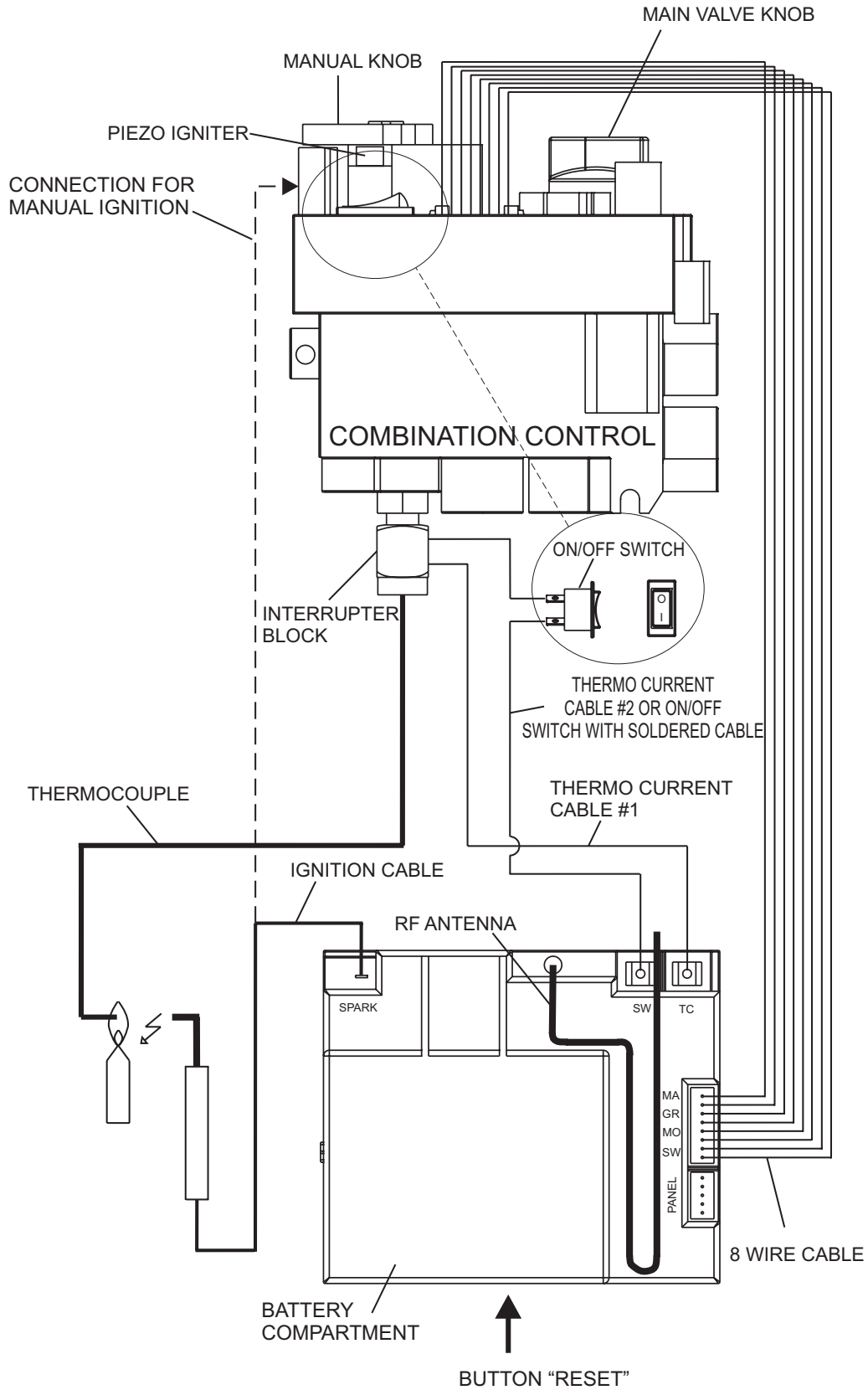

VFSE REMOTE ELECTRONIC IGNITION AND CONTROL SYSTEM

GENERAL NOTES

Radio Frequency Handset

433.92 MHz for Europe; 315 MHz for U.S. (FCC ID: RTD-G6R) and for Canada (IC: 4943A-G6R). This device complies with part 15 of the FCC Rules. Operation is subject to the following two conditions: (1) This device may not cause harmful interference, and (2) This device must accept any interference received, including interference that may cause undesired operation. Changes or modifications not expressly approved by the party responsible for compliance could void the user's authority to operate the equipment.

NOTICE:

Wiring of valve and receiver must be completed before starting ignition. Failure to do so could damage the electronics.

Batteries – Handset

- 1 x 9 V (quality alkaline recommended).
- Low battery indicator on handsets with display.
- Handsets without display: the red LED gets darker.
- Battery replacement is recommended after 2 years.

Batteries – Receiver

- 4 x 1.5 V "AA" (quality alkaline recommended).
- Low battery indication: frequent beeps for 3 seconds when motor turns.
- An AC Mains Adapter may be used instead of batteries.

NOTICE:

Only the Mertik Maxitrol AC Mains Adapter or one preapproved by Mertik Maxitrol can be used. Use of other adaptors can render the system inoperable.

- The module for fan speed control and light/dimmer includes mains power together with batteries in the receiver for automatic backup in case of power outage.
- Without using a mains adapter, battery replacement is recommended at the beginning of each heating season.

NOTICE:

The handsets and receivers, are not interchangeable with previous electronics. See Figure 17.



Figure 15

NOTICE:

Replacement handsets for CSA models also must have the same part number (see label).

SETTING THE ELECTRONICS CODE

(First time use only.)
Radio Frequency Handset
A code is selected automatically for all Mertik Maxitrol electronics from among 65,000 random codes available. The receiver has to learn the code of the handset:

- Press and hold the receiver's reset button (see figure 16) until you hear two (2) beeps. The first beep is short and the second beep is long. After the second beep, release the reset button.
- Within the subsequent 20 seconds press the (small flame) button on the handset until you hear two additional short beeps confirming the code is set. If you hear one long beep, this indicates the code learning sequence has failed or the wiring is incorrect.

NOTE: This is a one time setting only, and is not required after changing the batteries of the handset or receiver.

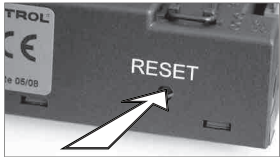
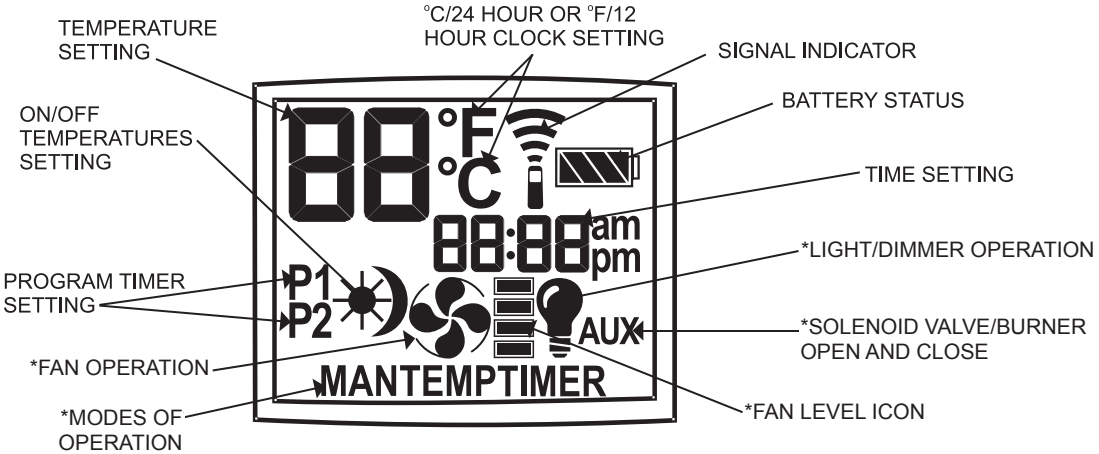

Figure 16



*FEATURE NOT AVAILABLE WITH THIS UNIT.

Figure 17

VFSE REMOTE ELECTRONIC IGNITION AND CONTROL SYSTEM

TO TURN ON APPLIANCE

WARNING

When pilot ignition is confirmed, motor turns automatically to maximum flame height.

- Turn MANUAL knob to the **ON**, full  counterclockwise position.
- Place ON/OFF switch (if equipped) in **I (ON)** position.

HANDSET

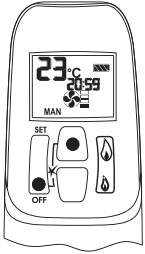

- Simultaneously press the OFF and  (large flame) buttons until a short beep confirms the start sequence has begun; release buttons.
- Continuing beeps confirm the ignition is in process.
- Once pilot ignition is confirmed, there is main gas flow.
- After main burner ignition the handset will automatically go into manual mode (CSA version, CE version).

WARNING

If the pilot does not stay lit after several tries, turn the main valve knob to off and follow the instructions “TURN OFF GAS TO APPLIANCE”.

STANDBY MODE (Pilot Flame)

Handset

- Press and hold  (small flame) to set appliance at pilot flame.

TO TURN OFF APPLIANCE

Handset

- Press OFF button

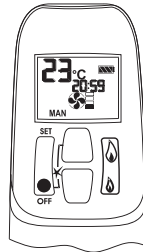

FLAME HEIGHT ADJUSTMENT

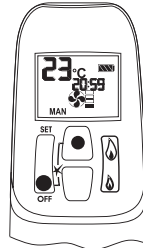

Handset

- In standby mode: Press and hold  (large flame) button to increase flame height.

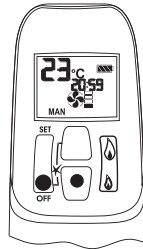

- Press and hold  (small flame) button to decrease flame height or to set appliance at pilot flame.





- For fine adjustment tap the  (large flame) or  (small flame) buttons.

Designated Low Fire and High Fire

- Double-click  (small flame) button. “LO” will be displayed.

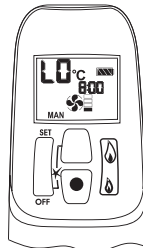
NOTE: Flame goes to high fire first before going to designated low fire.



- Double-click  (large flame) button. Flame automatically goes to high fire. “HI” will be displayed.



WARNING

If the appliance will not operate, follow the instructions “TURN OFF GAS TO APPLIANCE” on page 14.

VFSE REMOTE ELECTRONIC IGNITION AND CONTROL SYSTEM

TO OPEN AND CLOSE SOLENOID VALVE/BURNER

NOTE: The latching solenoid valve cannot operate manually. If the battery runs down it will remain in the last operating position. During normal operation the solenoid valve will be reset to the On position when the GV60 is switched OFF remotely.

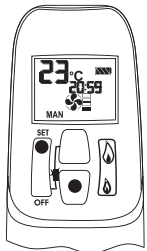

Burner OFF

- Upon ignition Main Burner and Decorative Burner are On.

- Simultaneously press SET and  (small flame) buttons to switch the Burner OFF. Printed instructions are on the battery cover. See Figure 18.

- Simultaneously press SET and  (large flame) buttons to switch Burner On. (The AUX symbol on the display indicates the solenoid valve is OPEN.)

NOTE: The operation of the AUX is blocked in timer OFF mode, when the setting of the  nighttime setback Temperature is

“ -- ”.

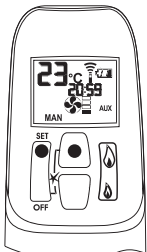

Burner ON



Figure 18

MODES OF OPERATION

- Briefly pressing the SET button changes the mode of operation in the following order:

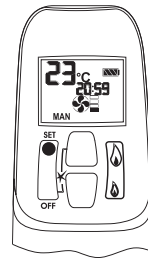

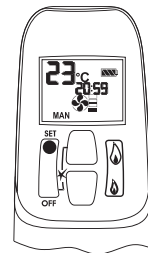

NOTE: Manual mode can also be reached by pressing either the

-  (large flame) or the  (small flame) button.

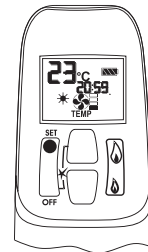

-  **Manual Mode**
Manual flame height adjustment.



-  **Daytime Temperature Mode**
(Appliance must be in standby mode; pilot ignited)
The room temperature is measured and compared to the set temperature. The flame height is then automatically adjusted to achieve the Daytime Set Temperature.

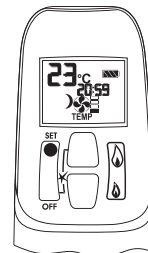

-  **Nighttime Setback Temperature Mode**
(Appliance must be in standby mode; pilot ignited)
The room temperature is measured and compared to the nighttime setback Temperature. The flame height is then automatically adjusted to achieve the nighttime setback Temperature.

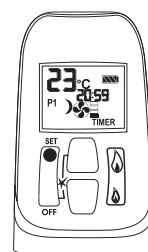

-  **Timer Mode**
(Appliance must be in standby mode; pilot ignited)
The Timers P1 and P2 (Program 1, Program 2) each can be programmed to go ON and OFF at specific times. For instructions see Timer Programming Mode.

NOTICE: The display shows the set temperature every 30 seconds.

VFSE REMOTE ELECTRONIC IGNITION AND CONTROL SYSTEM

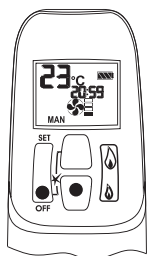

SETTING °C/24 HOUR OR °F/12 HOUR CLOCK

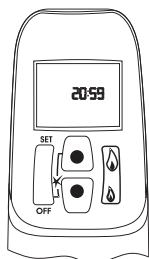

- Press OFF and  (small flame) button until display changes from Fahrenheit/12 hour clock to Celsius/24 hour clock and vice versa.

SETTING THE TIME





- The Time display will flash after either:
 - Installing the battery or
 - Simultaneously pressing the (large flame) and (small flame) buttons.
- Press  (large flame) button to set the hour.
- Press  (small flame) button to set the minute.
- Press **OFF** or simply wait to return to manual mode.

SETTING THE ON/OFF TEMPERATURES

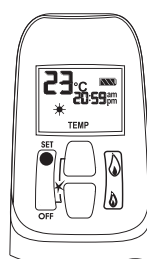

Setting the "DAYTIME" Temperature

DEFAULT SETTINGS:  TEMP (SUN), 23°C/74°F



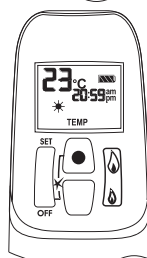

- Briefly press SET button to scroll to TEMP  TEMP (sun) mode. Hold the SET button until the TEMP flashes.

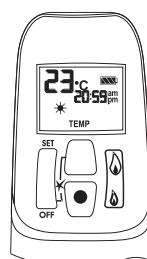

- Press  (large flame) button to increase  Daytime Set Temperature.



- Press  (small flame) button to decrease  Daytime Set Temperature.

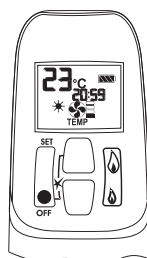



- Press **OFF** or simply wait to complete programming.

VFSE REMOTE ELECTRONIC IGNITION AND CONTROL SYSTEM

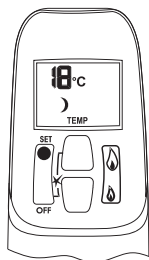

Setting the "NIGHTTIME SETBACK" Temperature

DEFAULT SETTINGS:  (MOON), "--" (OFF)



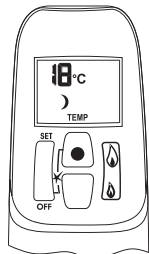

- Briefly press **SET** button to scroll to TEMP  (moon) mode. Hold the **SET** button until the TEMP flashes.

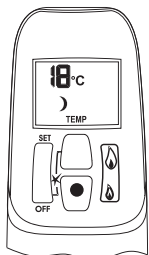

- Press  (large flame) button to increase the  Nighttime Setback Temperature.



- Press  (small flame) button to decrease the  Nighttime Setback Temperature.

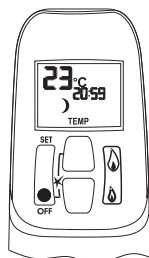

- Press **OFF** or simply wait to complete the programming.

SETTING PROGRAM TIMERS

Default Settings

CE: Program 1: P1 * :6:00am P1 > :8:00am
 CSA: Program 2: P2 * :11:50pm P2 > :11:50pm

- 2 ON times can be programmed * per day.
- CE: The day starts at 0:00, ends at 23:50.
- CSA: The day starts at 12:00am, ends at 11:50pm
- The ON/OFF times have to be programmed in the order $P1 * \leq P1 > < P2 * \leq P2 >$.
- If $P1 * = P1 >$ or $P2 * = P2 >$ the timer is deactivated.
- To have the fire over night, it can be set:
 CE: P2 > 23:50 and P1 * 0:00
 CSA: P2 > 11:50am and P1 * 12:00am

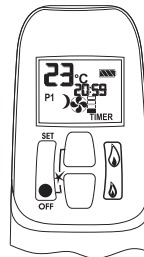

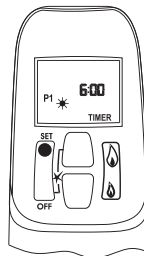

- Select Timer Mode by briefly pressing the **SET** button.

Setting P1 ON Time



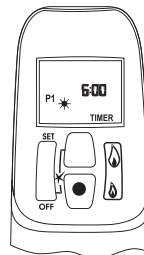

- Hold the **SET** button until P1 *  (sun) is displayed and the time flashes.

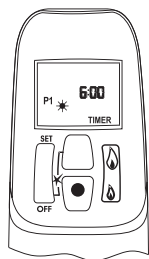

- Set the hour by pressing the  (large flame) button.

VFSE REMOTE ELECTRONIC IGNITION AND CONTROL SYSTEM



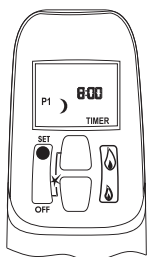

- Set the minutes by pressing the  (small flame) button.



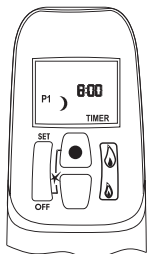

Setting P1 OFF Time

- Briefly press SET button to scroll to setting P1 OFF time. P1  (moon) is displayed and the time flashes.

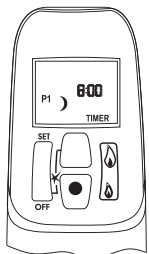

- Set the hour by pressing the  (large flame) button.



- Set the minutes by pressing the  (small flame) button.

Setting P2 ON Time

- Briefly press SET button to scroll to setting P2 ON time. P2  (sun) is displayed and the time flashes.
- See instructions SETTING P1 ON TIME.



Setting P2 OFF Time

- Briefly press SET button to scroll to setting P2 OFF time. P1  (moon) is displayed and the time flashes.
- See instructions SETTING P1 OFF TIME.
- This concludes programming Timers P1 and P2. Press OFF or wait. The handset will automatically save your changes.

MANUAL OPERATION

(Only possible, when MANUAL knob is used)

Access to the pilot burner is only required for ignition with a match. When turning main valve knob, do not force. Knob has a slip clutch that clicks until the end stops are reached. This allows for manual flame height adjustment as well as adjustment to pilot standby position.

1. Stop! Read the safety information included before proceeding.
2. Turn main valve knob to the off, full clockwise  position.
3. Turn MANUAL knob to the man, full clockwise  position.
4. Place ON/OFF switch (if equipped) in O (OFF position).
5. Wait five (5) minutes to clear out any gas. Verify that no gas is in the area around the appliance, including near the floor. If you detect gas stop! Follow "What to do if you smell gas" in the safety information on page 5. If no gas is present, proceed to step 6.
6. Place ON/OFF switch (if equipped) in I (On position).
7. With the MANUAL knob in man position a manual pilot valve operator and piezo ignitor (optional) are accessible.
8. Fully push down manual pilot valve operator and hold in, to start pilot gas flow (See Figure 19, page 28).

Ignition with match:



Immediately light the pilot with a match, while continuing to hold in the manual pilot valve operator for about one (1) minute after the pilot is lit. Release manual pilot valve operator. If pilot does not stay lit, wait five (5) minutes and repeat.

Ignition with piezo ignitor:

Change the ignition cable from the receiver to the valve (See Figure 19, page 28). Push in the piezo ignitor to ignite. If pilot does not stay lit, wait five (5) minutes and repeat.

WARNING

If the pilot does not stay lit after several tries, turn the gas control knob (main valve knob) to OFF and proceed to step 12.

9. If applicable, replace pilot access panel before proceeding.
10. Turn MANUAL knob to the on, full counterclockwise  position.
11. Turn main valve knob to the full on, full  counterclockwise position.
12. If the appliance will not operate, turn off the gas to the appliance.

VFSE REMOTE ELECTRONIC IGNITION AND CONTROL SYSTEM

TO TURN OFF GAS TO APPLIANCE

1. Place ON/OFF switch (if equipped) in **O** (OFF position).
2. If gas control is accessible turn main valve knob to the off full clockwise position.
3. Replace appliance access cover (if applicable).

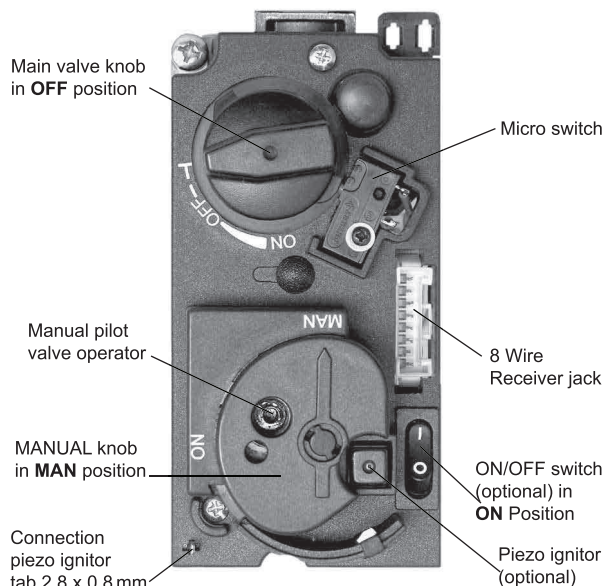

Figure 19

AUTOMATIC TURN DOWN

6 hour no motor movement

(CSA version)

- Manual Mode/Temperature/Timer Mode: The valve will turn to pilot flame if there is no change in flame height for a 6 hour period. In Temperature/Timer Mode if the ambient room temperature changes, the flame height will adjust automatically to maintain set temperature, and the fire will continue to function normally. The valve will turn to pilot flame if the set temperature and the ambient room temperature remain the same over a 6 hour period.

Receiver Overheating

(only if module is connected)

- Valve turns to pilot flame if the temperature in the receiver is higher than 140 °F (60 °C). The main burner comes back on only when the temperature is below 140 °F (60 °C).

1 Hour Turn Down for Special Receiver

(bedroom fireplaces only)

- The valve will turn to pilot flame if there is no change in flame height over a 1 hour period.

AUTOMATIC SHUT OFF

Low Battery Receiver

- With low battery power in the receiver the system shuts off the fire completely. This will not happen if the power supply is interrupted.

Five day shut off

(CSA version)

- The system shuts off the fire completely if there is no change in flame height for 5 days.

Second Thermocouple Shut Off

- Second Thermocouple Option: The system shuts off the fire if the main burner does not completely ignite approximately 20 seconds after ignition or after pushing the (large flame) button.

NOTE: Before the next ignition there is a 2 minute waiting period.

VFSV REMOTE CONTROL INSTRUCTIONS

NOTICE: This remote is for use on VFSV Models ONLY.

INTRODUCTION

This remote control system was developed to provide a safe, reliable, user-friendly remote control system for gas heating appliances. The system can be operated manually from the transmitter.

TRANSMITTER

The transmitter operates on a 12V (A23) battery that is included. Install the 12V battery supplied with the unit into the battery compartment. It is recommended that ALKALINE batteries always be used for this product. **Be sure the batteries are installed with the (+) and (-) ends facing the correct direction.**

The LED signal light should illuminate when either the **ON/OFF** or **HI/LOW** button is pressed. If the signal light does not illuminate, check the position of the transmitter's battery, and if the battery is fully charged.

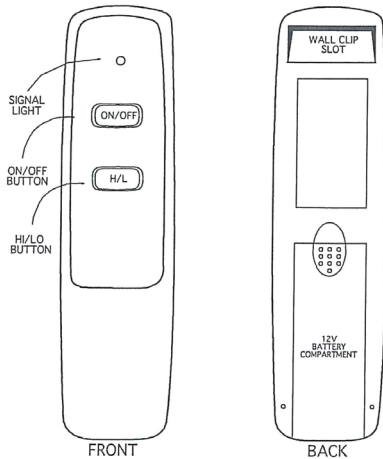

KEY SETTINGS

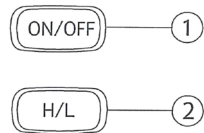

1. **ON/OFF** - This turns the appliance On or Off.
2. **H/L** - This controls the height of the flame. It has four levels: High, Medium High, Medium Low and Low. The H/L button will not turn the burner On or Off.

IMPORTANT: The remote receiver should be positioned where ambient temperatures do not exceed 130°F.

RECEIVER

Install the 4 AA-size batteries supplied with the unit. It is recommended that ALKALINE batteries always be used for this product. **Be sure the batteries are installed with the (+) and (-) ends facing the correct direction.**

The remote receiver has a 2-position slide switch for selecting the mode of operation, which is **OFF/REMOTE**

- **REMOTE:** The receiver must be in this position if you want to use the appliance, you must use the transmitter to turn on the appliance. If the system does not respond to the transmitter on initial use, check the battery positions in the remote. If that does not work, see the SECURITY CODE section.
- **OFF:** Will disable the remote receiver.

- It is suggested that the slide switch be placed in the **OFF** position if you will be away from your home for an extended period of time.

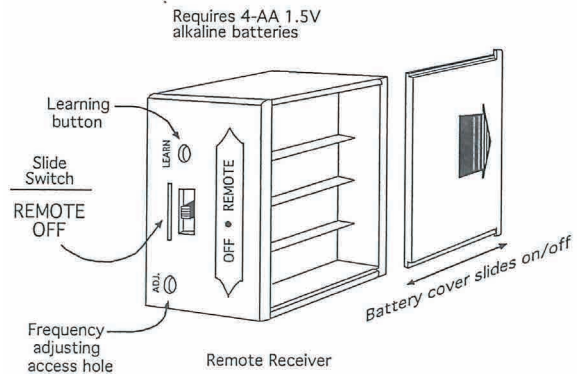

WIRING INSTRUCTIONS

WARNING

Do not connect remote receiver directly to 110-120vac power. This will burn out the receiver. Follow instructions from manufacturer of gas valve for correct wiring procedures. Improper installation of electric components can cause damage to gas valve and remote receiver.

CONNECT THE RECEIVER TO THE AF-1031 SERIES GAS VALVE WITH THE STEP MOTOR

- Do not install the 4 AA batteries into the receiver until the DC Step Motor is connected to the receiver. The receiver will calibrate the step motor once the batteries are installed.
- Connect the 4 pin female connector from the DC step motor to the 4-pin male connector on the wire harness.
- Connect the 4 pin female connector on the wire harness to the 4-pin connector on the back of the receiver.
- Install the 4 AA batteries in to the receiver.
- After receiver is connected to the DC step motor using the supplied wire harness, make sure to locate the receiver in an area that will not exceed the 130°F. This location will always be towards the front of the firebox.

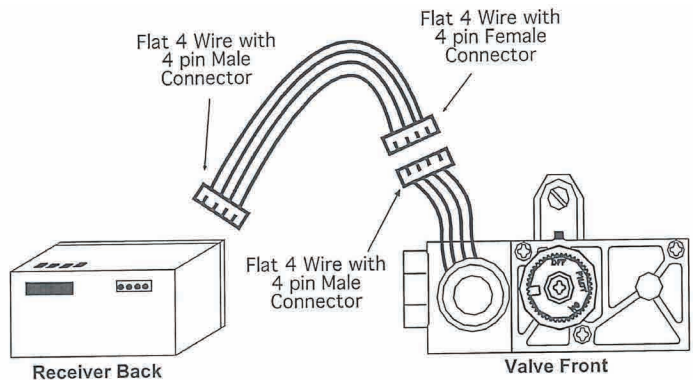

VFSV REMOTE CONTROL INSTRUCTIONS

THERMO-SAFETY FEATURE

When the ambient temperature inside the receiver case reaches 130°F, the RECEIVER will automatically send power to the step motor on the valve to shut the fireplace system off and the RECEIVER will begin emitting a series of 4 "beeps" every 2 seconds. When the ambient temperature at the RECEIVER drops between 120°F and 130°F, the user can reactivate the fireplace by pushing the ON/OFF button on the transmitter. When the ON/OFF button is pressed, the THERMISTOR "resets" itself and the fireplace will begin operating again. However, the "beeping" will continue if the ambient temperature remains between 120°F and 130°F. This "beeping" alerts the user that the RECEIVER should be repositioned so the ambient temperature drops below 120°F. When the temperature drops below 120°F, and the control is reset by pressing the ON/OFF button, the "beeping" will cease.

SECURITY CODES

This transmitter has one of 256 unique security codes. It may be necessary to program the remote receiver to learn the security code of the transmitter upon initial use, if batteries are replaced, or if using a replacement transmitter.

NOTE: This receiver can hold up to 3 transmitter codes. This if for the times when a second hand held transmitter or a wall transmitter is required.

- Make sure the receiver's slide switch is in the REMOTE position.
- Press and release the LEARN button on the receiver.
- When you hear the "beep", press and hold the ON/OFF or H/L button for about 2 seconds on the transmitter.
- You will then hear a series of beeps that indicated that your new transmitter has been accepted by the receiver.
- If you press the LEARN button on the receiver and you hear no beeps, the receiver is unable to retain any more transmitter codes (make sure that the transmitter and the receiver batteries are properly installed and fully charged).
- To delete all of the transmitter codes on your receiver, press and hold the LEARN button for 10 seconds. Then you will hear a series of beeps indicating that the receiver's memory has been cleared.

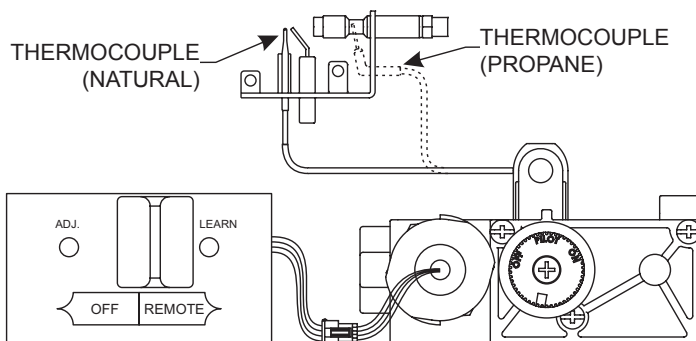

VFSV Wiring Diagram

TRANSMITTER WALL CLIP

The transmitter can be hung on a wall using the clip provided.

- Wood - Drill 1/8" pilot holes and install with screws provided.
- Plaster/Wallboard - Drill 1/4" holes, tap plastic anchors in with hammer then install with the screws provided.

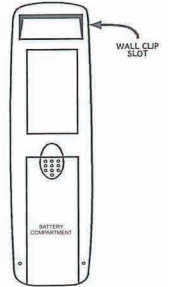

BATTERY LIFE

Life expectancy of the alkaline batteries in the transmitter and receiver should be at least 12 months. Check and replace all batteries:

- Annually.
- When operating range becomes reduced.
- When transmissions are not received by the remote receiver.
- If the remote receiver batteries measure less than 5.3 volts (all four batteries in combination).
- If the hand held transmitter battery measures less than 9.0 volts.

TROUBLESHOOTING



If you encounter problems with your fireplace system, the problem may be with either the fireplace itself or with the remote. Review the fireplace manufacturer's operation manual to make sure all connections are properly made. Then check the operation of the remote in the following manner:

- Make sure all batteries are correctly installed in the transmitter and receiver. Also check that the batteries are fully charged.
- Check batteries in transmitter to make sure contacts are touching (+) and (-) ends of battery. Bend metal contacts in for tighter fit.
- Be sure receiver and transmitter are within 20' - 25' operating range.
- Keep receiver from temperatures exceeding 130°F. Battery life will be shortened if exposed to high temperatures.
- If receiver is installed in a tightly enclosed metal surrounding, the operating distance will be shortened.
- Make sure the hand-held transmitter and remote receiver are communicating properly (see SECURITY CODES section).



FCC REQUIREMENTS

NOTICE: the manufacturer is not responsible for any radio or tv interference caused by unauthorized modifications to the equipment. Such modifications could void the user's authority to operate the equipment.

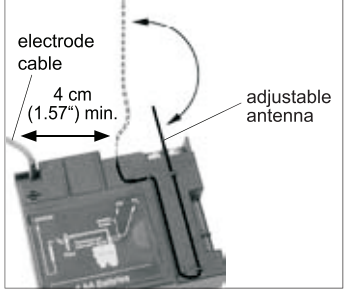

VFSE INTERMITTANT TROUBLESHOOTING

OBSERVED PROBLEM	POSSIBLE CAUSE	REMEDY
Will not operate with Handset	1. Transmitter batteries low	Replace Transmitter batteries. Quality alkaline recommended.
	2. Receiver batteries low	Replace Receiver batteries with 1.5V "AA" quality alkaline batteries.
	3. Optional Mains Adapter not operating properly	Check Mains Adapter.
	4. Check coding of Transmitter and Receiver (Initial sync.)	Learn new code (reset). See label on receiver.
	5. Transmitter distance limited	1. Straighten the antenna. 2. Replace Receiver. See wiring diagram page 15.
No transmission: (motor does not turn)	1. Dead batteries	Replace the batteries in the Receiver and/or Remote Handset (quality Alkaline recommended). <div style="border: 1px solid black; padding: 5px; margin: 5px 0;"> <p style="text-align: center;">WARNING</p> <p>Do not use metal tools to remove batteries. Doing so will render the Receiver inoperable. See Figure 15.</p> </div> <div style="text-align: center; margin: 5px 0;">  </div> <p style="text-align: center;">Figure 20</p> Application with internal and external battery box: <div style="border: 1px solid black; padding: 5px; margin: 5px 0;"> <p style="text-align: center;">WARNING</p> <p>Battery clip (See Figure 21) must not come into contact with metal parts after unplugging the external battery holder, because there is voltage stored in the Receiver.</p> </div> <div style="text-align: center; margin: 5px 0;">  </div> <p style="text-align: center;">Figure 21</p>
	2. Receiver must learn new code	Press and hold the Receiver's reset button (See figure 22) until you hear 2 acoustic signals. After the second, longer acoustic signal, release the reset button. Within the subsequent 20 seconds press the (small flame) button on the Remote Handset until you hear an additional long acoustic signal confirming the new code is set. <div style="text-align: center; margin: 5px 0;">  </div> <p style="text-align: center;">Figure 22</p>

VFSE INTERMITTANT TROUBLESHOOTING

OBSERVED PROBLEM	POSSIBLE CAUSE	REMEDY
No transmission: (motor does not turn) (continued)	3. The Receiver is surrounded by metal, reducing the transmission range.	Change the position of the adjustable antenna. <div style="border: 1px solid black; padding: 5px; margin: 5px 0;"> <p style="text-align: center;">WARNING</p> <p>Make sure that the adjustable antenna is not too close to the electrode cable and ignition coil (beneath the cover) It will damage the Receiver. See Figure 23.</p> </div> <div style="text-align: center;">  </div> <p style="text-align: center;">Figure 23</p>
	4. Receiver	Replace receiver and reprogram code
	5. Transmitter	Replace the Transmitter and reprogram code
	6. Bent pins on 8 Wire Connector on the Valve and Receiver. See Figure 24.	Straighten pins on 8 Wire Connector <div style="text-align: center;">  </div> <p style="text-align: center;">Figure 24</p>
	7. Wiring at Valve damaged	Replace valve.
	8. IR-Eye (Infrared remote only)	Replace (check and change).
No Ignition; no tone	1. Receiver	Replace Receiver and reprogram code.
No Ignition; one 5 second continuous tone:	1. ON/OFF switch is in (O) OFF position	Push switch to (-) ON position (See Figure 25) <div style="text-align: center;">  </div> <p style="text-align: center;">ON/OFF Switch 8 Wire Connector Figure 25</p>
	2. Loose wire	Secure wire
	3. Receiver	Replace Receiver and reprogram code
	4. Bent pins on 8 wire Connector on the Valve and Receiver. See Figure 24.	Straighten pins on 8 Wire Connector
	5. Valve	Replace Valve. Do not overtighten the Thermocouple Interrupter

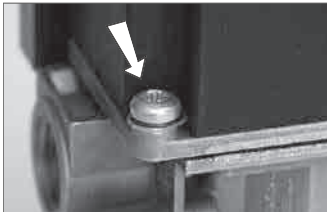
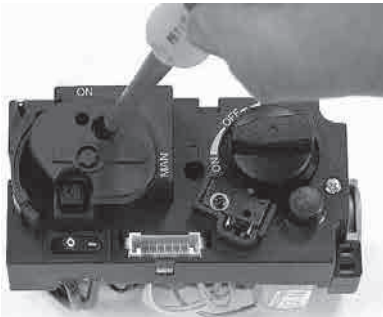
VFSE INTERMITTANT TROUBLESHOOTING

OBSERVED PROBLEM	POSSIBLE CAUSE	REMEDY
<p>Ignition stops after the first spark</p>	<p>1. Loose ground connection at the valve</p> <div style="text-align: center;">  <p>Figure 26</p> </div>	<p>Check ground connection at the Valve and tighten screw. See Figure 26.</p>
<p>No pilot flame but spark</p>	<p>1. No gas supply</p> <p>2. Air in the pilot supply line</p> <p>3. No spark and Pilot Burner</p> <p>4. Valve</p> <p>5. Receiver</p> <p>6. Thermocouple circuit wire incorrectly</p>	<p>Check the gas supply</p> <p>Purge the line or start ignition several times</p> <p>Check pilot setup, page 14. Check wiring connections. Check for spark in location along cable.</p> <p>Replace Valve. Do not overtighten the Thermocouple Interrupter.</p> <p>Replace Receiver and reprogram code</p> <p>Check polarity of the Thermocouple wires</p>
<p>Pilot is lit and sparking stops. Valve shuts off after 10 to 60 seconds. Valve does not operate manually:</p> <p>NOTE: For manual operation turn the Valve knob to the manual position and hold the safety magnet open with a pen for approximately 60 seconds. See Figure 27.</p> <div style="text-align: center;">  <p>Figure 27</p> </div>	<p>1. Not enough voltage generated from the Thermocouple or too much resistance in the circuit.</p> <p>NOTE: To find which part of the circuit is causing the problem, a checklist for each application can be prepared using an Excel calculation available from Mertik Maxitrol.</p> <p>Possible parts causing excessive resistance are: ON-OFF Switch, Temperature Switches, Thermocurrent Connections, Receiver.</p> <p>2. Thermocouple</p> <p>3. Low inlet pressure to Valve</p> <p>4. Valve</p>	<p>Use a digital multimeter set in the mV range and measure the voltage by connecting the test leads to the spade connector. Spade connector is located on the outer surface, directly beside the magnet nut. See Figure 28. The available voltage must be at least 5 mV. The manufacturer must specify the drop time for the application. The drop time can be measured after the Thermocouple is heated.</p> <div style="text-align: center;">  <p>Figure 28</p> </div> <p>Replace Thermocouple</p> <p>Confirm sufficient inlet pressure to the Valve. Adjust or replace inlet regulator if necessary.</p> <p>Replace Valve. Do not overtighten the Thermocouple Interrupter</p>
<p>Frequent beeps for 3 seconds while motor turns</p>	<p>1. Batteries (Receiver) are low</p>	<p>Replace the batteries in the Receiver and/or Remote Handset (quality Alkaline recommended).</p> <div style="border: 1px solid black; padding: 5px; margin-top: 10px;"> <p style="text-align: center;">WARNING</p> <p>Do not use metal tools to remove batteries. Doing so will render the Receiver inoperable. See Figure 20.</p> </div>

VFSE INTERMITTANT TROUBLESHOOTING

OBSERVED PROBLEM	POSSIBLE CAUSE	REMEDY
Pilot flame lights but there is no main gas flow	1. Manual override knob (if equipped) is in MAN position.	Turn manual override knob to ON position (See Figure 19) .
	2. Valve turned down to pilot flow.	Turn flame to high fire by pressing up button on remote handset.
	3. Valve	Replace Valve. Do not overtighten the Thermocouple Interrupter
Latching Solenoid does not work.	1. Loose connection	Check connection is tight and pins are straight
	2. Latching Solenoid	Replace Latching Solenoid
	3. Receiver	Replace Receiver and reprogram code
	4. Handset	Check that the Handset shows the AUX-symbol if you press SET + UP
The remote receiver is responding and the pilot is lighting, but then quickly drops out followed by three fast acoustic signals	1. Weak batteries - between 5.5 volts to 5 volts	Check battery voltage. See Figure 29. Note: The black probe is on the second battery from the right, and the red probe is on the far right battery in Figure 28 . If the voltage is low, replace Receiver batteries with 1.5V "AA" quality alkaline batteries.
The remote receiver is beeping but not lighting the pilot	1. Weak batteries - below 5 volts	Check battery voltage. See Figure 29. If the voltage is low, replace Receiver batteries with 1.5V "AA" quality alkaline batteries.



Figure 29

VFSE INTERMITTANT TROUBLESHOOTING

OBSERVED PROBLEM	POSSIBLE CAUSE	REMEDY
<p>New remote receiver batteries have been installed, but the receiver is not responding to the handheld remote</p>	<p>1. Receiver must learn new code</p>	<p>Press and hold the Receiver's reset button (See Figure 30) until you hear 2 acoustic signals. After the second, longer acoustic signal, release the reset button. Within the subsequent 20 seconds press the (small flame) button on the Remote Handset until you hear an additional long acoustic signal confirming the new code is set.</p> <div data-bbox="1149 495 1422 625" style="text-align: center;">  </div> <p style="text-align: center;">Figure 30</p> <p>NOTE: It may take several attempts for the receiver to learn the code. Let a minute pass between each attempt to reset the receiver. If after three attempts the receiver has not programmed a code, remove the batteries for two minutes. Replace the batteries and restart the learning process.</p> <p>NOTE: A long continuous acoustic signal after any step in this process means the remote has failed to pick up the signal. Restart the learning process.</p> <p>NOTE: If pushing the high flame and Off on the receiver results in a long acoustic signal, make sure the on/off switch is in the "ON" position on the valve.</p> <p>NOTE: If the valve is beeping and the motor drive makes a slight movement, then back but there is no spark, check to make sure the spark wire is connected to the receiver box pin location.</p> <p>NOTE: Continuous acoustic signaling means the module is attempting ignition. Three short, fast acoustic signals mean failed ignition.</p>

PILOT FLAME CHARACTERISTICS

Figure 31 shows a correct pilot flame pattern. The correct flame will be blue and will extend beyond the thermocouple. The flame will surround the thermocouple just below the tip. A slight yellow flame may occur where the pilot flame and main burner flame meet. Figure 31 shows an incorrect pilot flame pattern. The incorrect pilot flame is not touching the thermocouple. This will cause the thermocouple to cool. When the thermocouple cools, the heater will shut down.

Cleaning and Maintenance/Pilot

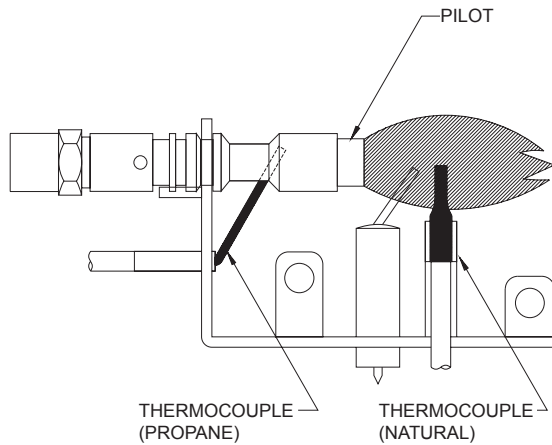

Correct Pilot Flame Pattern
Figure 31

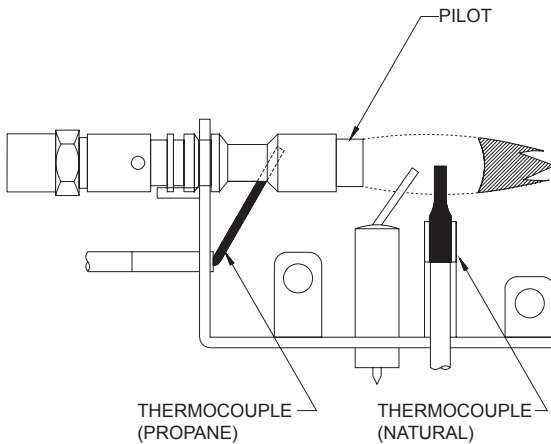

Incorrect Pilot Flame Pattern
Figure 32

If pilot flame pattern is incorrect, as shown in **Figure 32**

- See Troubleshooting, page 39.

Cleaning and Maintenance/Pilot Oxygen Depletion Sensor Pilot

When the pilot has a large yellow tip flame, clean the Oxygen Depletion Sensor as follows:

1. Clean the ODS pilot by loosening nut B from the pilot tubing. When this procedure is required, grasp nut A with an open end wrench.
2. Blow air pressure through the holes indicated by the arrows. This will blow out foreign materials such as dust, lint and spider webs. Tighten nut B also by grasping nut A.

⚠ WARNING

Never use needles, wires, or similar cylindrical objects to clean the pilot to avoid damaging the calibrated ruby that controls the gas flow.

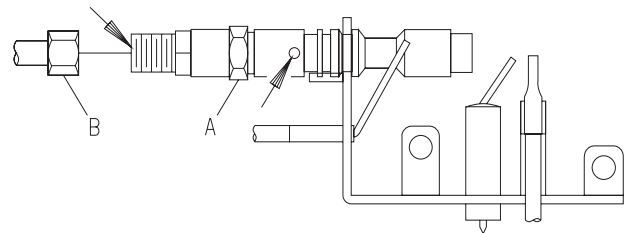

Figure 33

PILOT FLAME CHARACTERISTICS (CONT'D)

Figure 34 shows a correct pilot flame pattern. The correct flame will be blue and will extend beyond the thermocouple. The flame will surround the thermocouple just below the tip. A slight yellow flame may occur where the pilot flame and main burner flame meet. Figure 34 shows an incorrect pilot flame pattern. The incorrect pilot flame is not touching the thermocouple. This will cause the thermocouple to cool. When the thermocouple cools, the heater will shut down.

Cleaning and Maintenance/Pilot

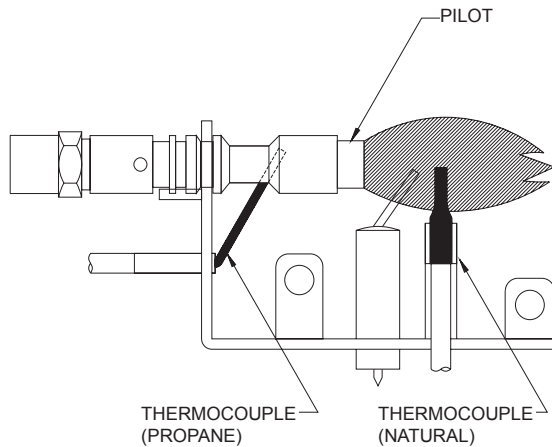
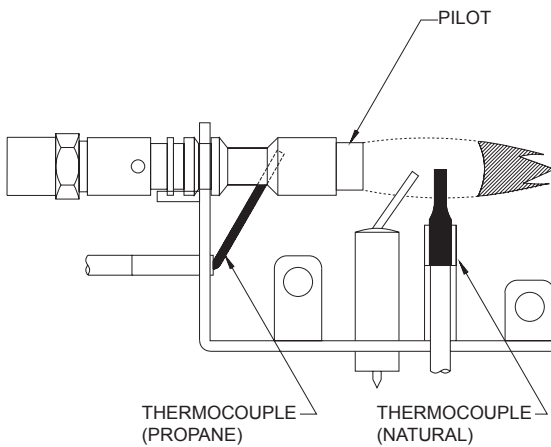

Figure 34 - Correct Pilot Flame Pattern



Incorrect Pilot Flame Pattern
Figure 35

If pilot flame pattern is incorrect, as shown in Figure 35

- See Troubleshooting, page 39.

Cleaning and Maintenance/Pilot

Oxygen Depletion Sensor Pilot

When the pilot has a large yellow tip flame, clean the Oxygen Depletion Sensor as follows:

1. Clean the ODS pilot by loosening nut B from the pilot tubing. When this procedure is required, grasp nut A with an open end wrench.
2. Blow air pressure through the holes indicated by the arrows. This will blow out foreign materials such as dust, lint and spider webs. Tighten nut B also by grasping nut A.

⚠ WARNING

Never use needles, wires, or similar cylindrical objects to clean the pilot to avoid damaging the calibrated ruby that controls the gas flow.

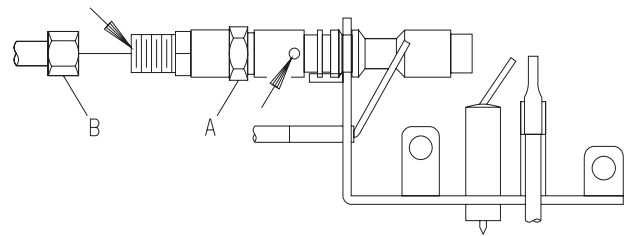

Figure 36

CLEANING AND SERVICING

Annual inspection and cleaning by your dealer or qualified service technician is recommended to prevent malfunction and/or sooting.

TURN OFF HEATER AND ALLOW TO COOL BEFORE CLEANING.

Remove logs, handling carefully by holding gently at each end. Gloves are recommended to prevent skin irritation from ceramic fibers. If skin becomes irritated, wash gently with soap and water. Refer to manual for correct log placement.

PERIODIC CLEANING – Refer to parts diagram for location of items discussed below.

- Do not use cleaning fluid to clean logs or any part of heater.
- Logs - brush with soft bristle brush or vacuum with brush attachment.
- Remove loose particles and dust from the burner areas, controls, piezo covers and grate. Don't remove media from inside burner box.
- Inspect and clean burner air intake hole. Remove lint or particles with brush. Failure to keep air intake hole clean will result in sooting and poor combustion.

ANNUAL CLEANING/INSPECTION – Refer to parts diagram for location of items discussed below.

- Inspect and clean burner air intake hole. Remove lint or particles with vacuum or brush. Failure to keep air intake hole clean will result in sooting and poor combustion.
- Inspect and clean all burner ports.
- Inspect ODS pilot for operation and accumulation of lint at air intake holes.
- Verify flame pattern and log placement for proper operation.
- Verify smooth and responsive ignition of main burner.
- Check level of ceramic media in burner. Burner should be full, up to the level of openings in burner top.

NOTICE: (Wiring harness located in envelope)

Connect black/red 3/16" terminal wire from receiver to 3/16" terminal on valve. Connect black 1/4" terminal wire from receiver to 1/4" terminal on valve. Install remote receiver cover over receiver when receiver is installed into fireplace area. Locate receiver and cover to the right and forward of valve. (Do not put receiver behind logs).

TROUBLESHOOTING

SYMPTOMS - POSSIBLE CAUSES AND CORRECTION

1. **When ignitor button is pressed, there is no spark at ODS/pilot.**
 - a. Ignitor electrode positioned wrong - Replace pilot.
 - b. Ignitor electrode is broken - Replace pilot.
 - c. Ignitor electrode not connected to ignitor cable - Reconnect ignitor cable.
 - d. Ignitor cable pinched or wet. Keep ignitor cable dry - Free ignitor cable if pinched by any metal or tubing.
 - e. Broken ignitor cable - Replace ignitor cable.
 - f. Bad piezo ignitor - Replace piezo ignitor.
2. **Appliance produces unwanted odors.**
 - a. Appliance burning vapors from paint, hair spray, glues, etc. - Ventilate room. Stop using odor causing products while heater is running.
 - b. Gas leak - Locate and correct all leaks.
3. **Appliance shuts off during use. (Pilot and main burner are off.)**
 - a. Not enough fresh air is available for ODS/pilot to operate - Open window and/or door for ventilation.
 - b. Low line pressure - Contact local gas company.
 - c. ODS/pilot is partially clogged - Clean ODS/pilot.
 - d. Defective thermocouple - Replace pilot.
4. **Appliance shuts off during use. (Pilot stays on.)**
 - a. Low line pressure - Check line pressure to the valve.
5. **Gas odor even when control knob is in OFF position.**
 - a. Gas leak - Locate and correct all leaks.
 - b. Control valve defective - Replace control valve.
6. **When ignitor button is pressed, there is spark at ODS/pilot, but no ignition.**
 - a. Gas supply turned off or manual shutoff valve closed - Turn on gas supply or open manual shutoff valve.
 - b. Control knob not in PILOT position - Turn control knob to PILOT position.
 - c. Control knob not pressed in while in PILOT position - Press in control knob while in PILOT position.
 - d. Air in gas lines when installed - Continue holding down control knob. Repeat igniting operation until air is removed.
 - e. ODS/pilot is clogged - Replace ODS/pilot assembly or get it serviced.
 - g. Gas regulator setting is not correct - Replace gas regulator.
7. **ODS/pilot lights but flame goes out when control knob is released.**
 - a. Control knob not fully pressed in - Press in control knob fully.
 - b. Control knob not pressed in long enough - After ODS/pilot lights, keep control knob pressed in 30 seconds.
 - c. Manual Shutoff valve not fully open - Fully open manual shutoff valve.
 - d. Thermocouple connection loose at control valve - Hand tighten until snug, then tighten 1/4 turn more.
 - e. Pilot flame not touching thermocouple, which allows thermocouple to cool, causing pilot flame to go out. This problem could be caused by either low gas pressure or dirty or partially clogged ODS/pilot - Contact local gas company.
 - f. Thermocouple damaged - Replace thermocouple.
 - h. Control valve damaged - Replace control valve.
8. **Burner does not light after ODS/pilot is lit.**
 - a. Burner orifice clogged - Clean burner or replace main burner orifice.
 - b. Burner orifice diameter is too small - Replace burner orifice.
 - c. Inlet gas pressure is too low - Contact qualified service person.
9. **If burning at main burner orifice occurs (a loud, roaring blow torch noise).**
 - a. You must turn off burner assembly and contact a qualified service person.
 - b. Manifold pressure is too low - Contact local gas company.
 - c. Burner orifice clogged - Clean burner or replace burner orifice.
10. **Logs appear to smoke after initial operation.**
 - a. Vapors from paint or curing process of logs - Problem will stop after a few hours of operation. Run the heater with the damper open if you have one, or open a window for the first few hours.
Log heater is intended to be smokeless. Turn OFF heater and call qualified service person.
11. **Heater produces a whistling noise when main burner is lit.**
 - a. Turning control knob to HIGH position when main burner is cold - Turn control knob to LOW position and let warm up for a minute.
 - b. Air in gas line - Operate burner until air is removed from line. Have gas line checked by local gas company.
 - c. Dirty or partially clogged burner orifice - Clean burner or replace burner orifice.
12. **No gas to pilot.**
 - a. Propane regulator shut down due to inlet pressure too high - Verify propane tank regulator is installed and set at 11" to 13" w.c. Replace regulator on heater.

If the gas quality is bad, your pilot may not stay lit, the burners may produce soot and the heater may backfire when lit. If the gas quality or pressure is low, contact your local gas supplier immediately.

VFSE PARTS LIST

Attention: When ordering parts, it is very important that part number and description of part coincide.

INDEX NO.	PART NO.	DESCRIPTION
1	15425	REAR LOG SUPPORT (16" MODELS)
1	15426	REAR LOG SUPPORT (18" MODELS)
1	15427	REAR LOG SUPPORT (24" MODELS)
1	15428	REAR LOG SUPPORT (30" MODELS)
2	11376	BURNER SUPPORT - LEFT
3	P200	ORIFICE FITTING
4	P250	ORIFICE - PROPANE 18"
4	P245	ORIFICE - PROPANE 24"
4	P265	ORIFICE - PROPANE 30"
4	P243	ORIFICE - NATURAL 18"
4	P244	ORIFICE - NATURAL 24"
4	P211	ORIFICE - NATURAL 30"
5	R5675	AIR SHUTTER - PROPANE
5	R12678	AIR SHUTTER - NATURAL 1/16" OPENING 16", 24", 30" MODELS (PURPLE)
5	R12681	AIR SHUTTER - NATURAL 1/8" OPENING 18" MODELS (BLUE)
6	R5170	PILOT, PROPANE
6	R5171	PILOT, NATURAL
7	11833	PILOT SHIELD (NATURAL ONLY)
8	R7063	PILOT REGULATOR (NATURAL ONLY)
9	12348	BURNER ASSEMBLY (16" PROPANE MODELS)
9	12437	BURNER ASSEMBLY (16" NATURAL MODELS)
9	18838	BURNER ASSEMBLY (18" MODELS)
9	17370	BURNER ASSEMBLY (24" MODELS)
9	17386	BURNER ASSEMBLY (30" MODELS)
10	11308	BURNER SUPPORT - RIGHT WITH VALVE BRACKET
11	R10563	VALVE, MAXITROL (PROPANE)
11	R10562	VALVE, MAXITROL (NATURAL)
12	R11575	REMOTE CONTROL KIT (INCLUDES TRANSMITTER, HARNESS, & RECEIVER)
13	R10572	CONNECTOR, THERMOCOUPLE
14	11370*	GRATE ASSEMBLY (18" MODELS) (2 REQ'D)

INDEX NO.	PART NO.	DESCRIPTION
14	16178*	GRATE ASSEMBLY (24"&30" MODELS) (2 REQ'D)
*Requires 2/Grate ASM of R9628 Clips		
NS	R10573	3/8" NPT, HEX PLUG
NS	R10559	BATTERY, 9-VOLT
NS	R2809	DAMPER CLAMP
NS	11788	DECORATIVE ROCK
NS	R10518	FASTENER, HOOK
NS	R10519	FASTENER, LOOP
NS	R11946	IGNITER WIRE
NS	15998	ROCKWOOL (16" MODELS)
NS	15999	ROCKWOOL (18" MODELS)
NS	15970	ROCKWOOL (24" & 30" MODELS)
NS	R10569	SWITCH AND WIRE ASSEMBLY
NS	11335	TUBING ASSEMBLY - PROPANE VALVE TO PILOT
NS	14041	TUBING ASSEMBLY - NATURAL REGULATOR TO PILOT
NS	14040	TUBING ASSEMBLY - NATURAL VALVE TO REGULATOR
NS	11291	TUBING ASSEMBLY - VALVE TO BURNER
NS	R10570	WIRE ASSEMBLY, THERMOCOUPLE

NS - NOT SHOWN

VFSE PARTS VIEW

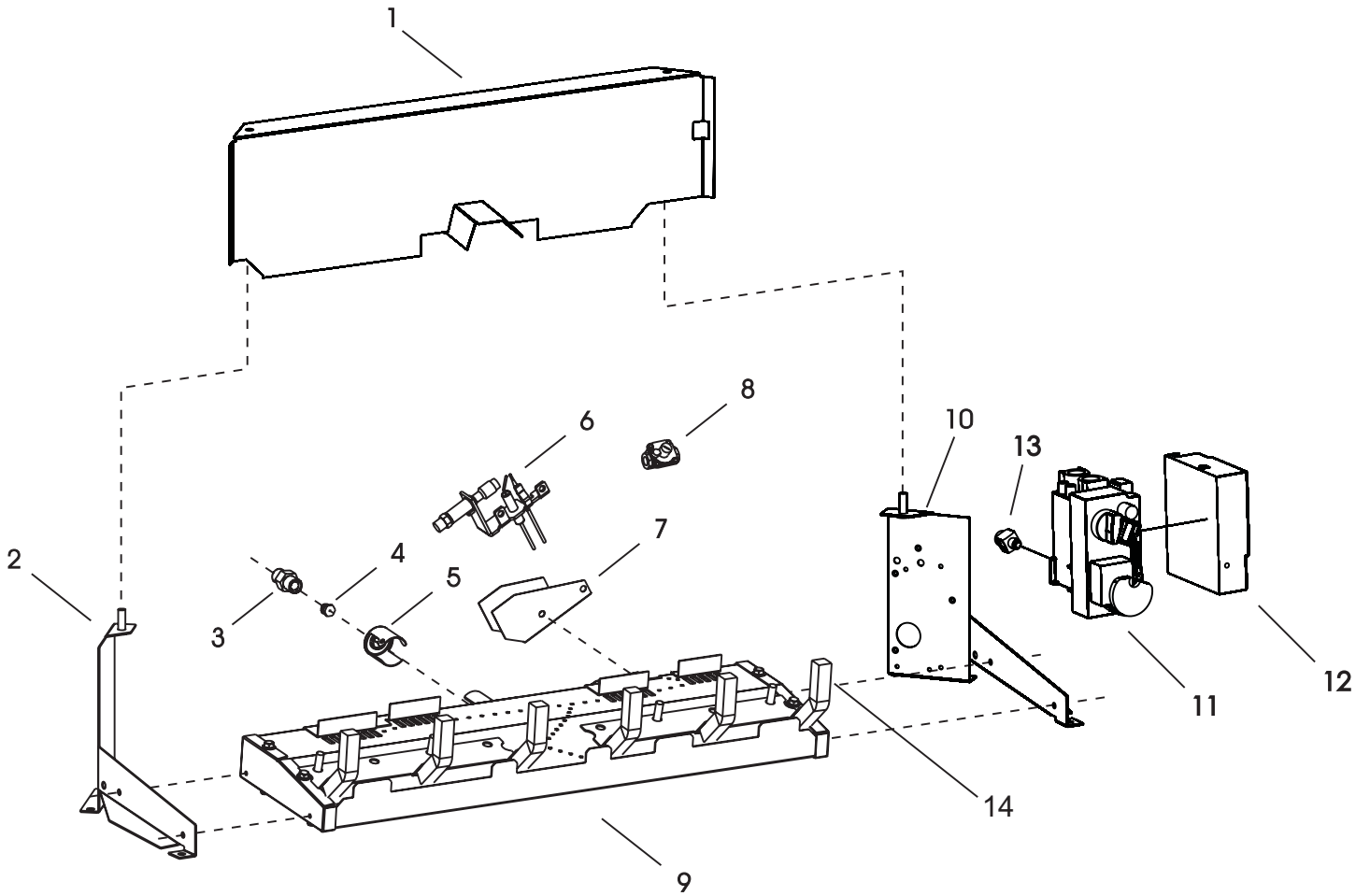

VFSV PARTS LIST

Attention: When ordering parts, it is very important that part number and description of part coincide.

INDEX NO.	PART NO.	DESCRIPTION
1	15425	REAR LOG SUPPORT (16" MODELS)
1	15426	REAR LOG SUPPORT (18" MODELS)
1	15427	REAR LOG SUPPORT (24" MODELS)
1	15428	REAR LOG SUPPORT (30" MODELS)
2	11376	BURNER SUPPORT - LEFT
3	P200	ORIFICE FITTING
4	P308	ORIFICE - PROPANE 16"
4	P210	ORIFICE - PROPANE 18"
4	P304	ORIFICE - PROPANE 24"
4	P265	ORIFICE - PROPANE 30"
4	P286	ORIFICE - NATURAL 16"
4	P243	ORIFICE - NATURAL 18"
4	P211	ORIFICE - NATURAL 24"
4	P209	ORIFICE - NATURAL 30"
5	R5675	AIR SHUTTER - PROPANE
5	R12678	AIR SHUTTER - NATURAL 1/16" OPENING 16", 24", 30" MODELS (PURPLE)
5	R12681	AIR SHUTTER - NATURAL 1/8" OPENING 18" MODELS (BLUE)
6	R5170	PILOT, PROPANE
6	R5171	PILOT, NATURAL
7	11833	PILOT SHIELD (NATURAL ONLY)
9	12348	BURNER ASSEMBLY (16" PROPANE MODELS)
9	12347	BURNER ASSEMBLY (16" NATURAL MODELS)
9	18838	BURNER ASSEMBLY (18" MODELS)
9	17370	BURNER ASSEMBLY (24" MODELS)
9	17386	BURNER ASSEMBLY (30" MODELS)
10	26291	BURNER SUPPORT RIGHT (18", 24", & 30" MODELS)
10	26321	BURNER SUPPORT RIGHT (16" MODELS)
14	R10613	VALVE, AF1110
15	R9761	PIEZO IGNITOR
16	27017	IGNITER BRACKET
17	R11031	45° STREET ELBOW
18	R10689	REGULATOR, 10.0 W.C.
18	R10618	REGULATOR, 4.0 W.C.
19	27016	VALVE BRACKET

INDEX NO.	PART NO.	DESCRIPTION
20	11370*	GRATE ASSEMBLY (18" MODELS) (2 REQ'D)
20	16178*	GRATE ASSEMBLY (24" & 30" MODELS) (2 REQ'D)
*Requires 2/Grate ASM of R9628 Clips		
NS	R2809	DAMPER CLAMP
NS	11788	DECORATIVE ROCK
NS	R8898	NIPPLE, 3/8 X 3/8 X 1 BLACK IRON
NS	27018	PILOT TUBE - VALVE TO PILOT (NATURAL & PROPANE)
*A - NS	R10620	REMOTE RECEIVER AND TRANSMITTER, PROPANE
*B - NS	R10619	REMOTE RECEIVER AND TRANSMITTER, NATURAL
NS	15998	ROCKWOOL (16" MODELS)
NS	15999	ROCKWOOL (18" MODELS)
NS	15970	ROCKWOOL (24" & 30" MODELS)
NS	11291	TUBING ASSEMBLY - VALVE TO BURNER
NS	R2789	WIRE, IGNITER, 12"

NS - NOT SHOWN

*A - **NOTICE:** R10620 - (REMOTE RECEIVER AND TRANSMITTER, PROPANE) CONTAINS:

- R10614 - TRANSMITTER
- R10616 - REMOTE RECEIVER
- R10708 - REMOTE WIRE HARNESS

*B - **NOTICE:** R10619 - (REMOTE RECEIVER AND TRANSMITTER, NATURAL) CONTAINS:

- R10614 - TRANSMITTER
- R10615 - REMOTE RECEIVER
- R10708 - REMOTE WIRE HARNESS

VFSV PARTS VIEW

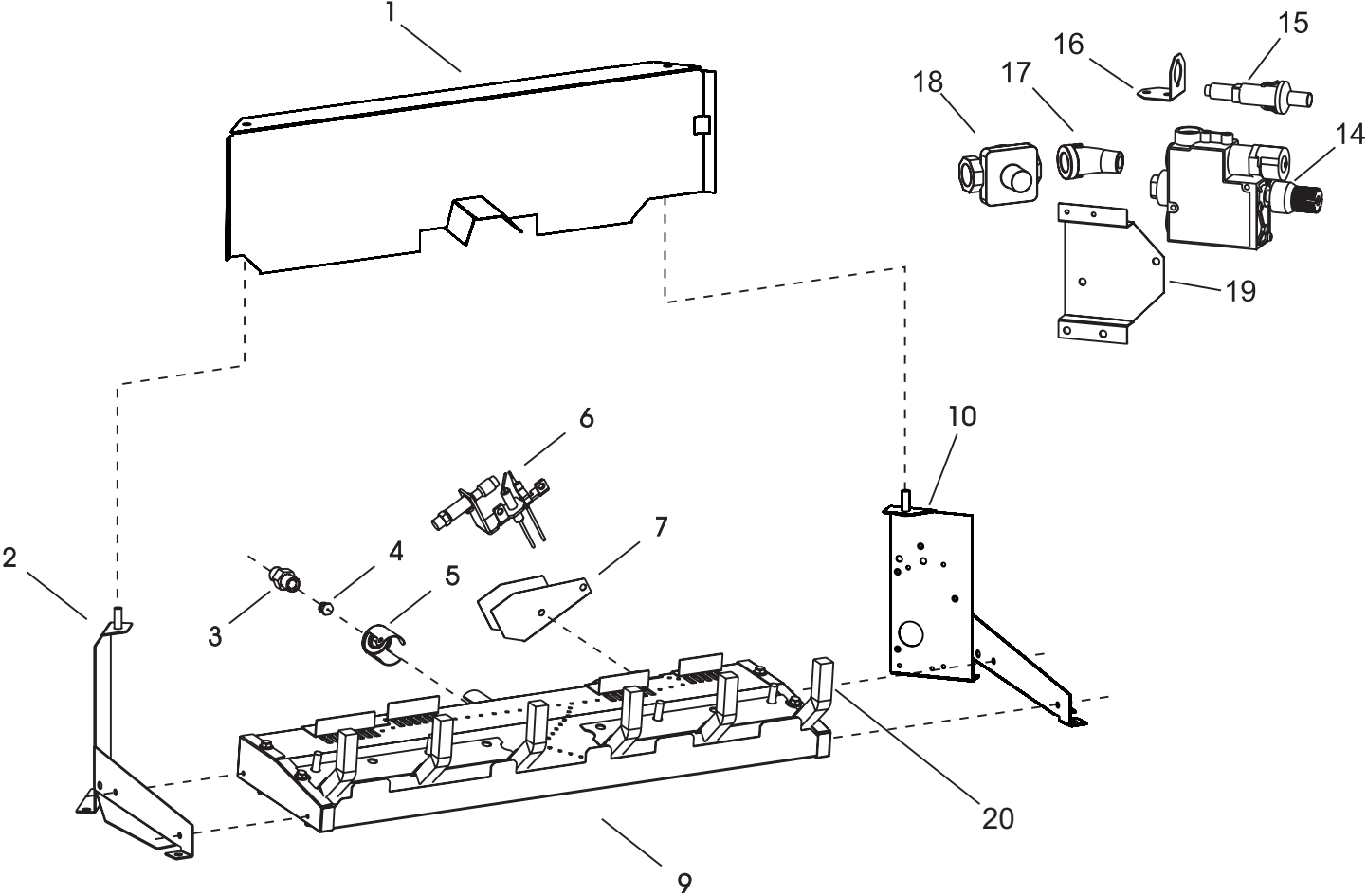

APPLIANCE SERVICE HISTORY

Date	Dealer Name	Service Technician Name	Service Performed/Notes

MASTER PARTS DISTRIBUTOR LIST

To Order Parts Under Warranty, please contact your local Empire dealer. See the dealer locator at www.empirecomfort.com. To provide warranty service, your dealer will need your name and address, purchase date and serial number, and the nature of the problem with the unit.

To Order Parts After the Warranty Period, please contact your dealer or one of the Master Parts Distributors listed below. This list changes from time to time. For the current list, please click on the Master Parts button at www.empirecomfort.com. Please note: Master Parts Distributors are independent businesses that stock the most commonly ordered Original Equipment repair parts for Heaters, Grills, and Fireplaces manufactured by Empire Comfort Systems Inc.

Dey Distributing

1401 Willow Lake Boulevard
Vadnais Heights, MN 55101

Phone: 651-490-9191

Toll Free: 800-397-1339

Website: www.deydistributing.com

Parts: Heater, Hearth and Grills

F. W. Webb Company

200 Locust Street
Hartford, CT 06114

Phone: 860-722-2433

Toll Free: 800-243-9360

Fax: 860-293-0479

Toll Free Fax: 800-274-2004

Websites: www.fwwebb.com & www.victormfg.com

Parts: Heater, Hearth and Grills

East Coast Energy Products

10 East Route 36
West Long Branch, NJ 07764

Phone: 732-870-8809

Toll Free: 800-755-8809

Fax: 732-870-8811

Website: www.eastcoastenergy.com

Parts: Heater, Hearth and Grills

HOW TO ORDER REPAIR PARTS

Parts Not Under Warranty

Parts can be ordered through your Service Person, Dealer, or a Master Parts Distributor. See this page for the Master Parts Distributors list. For best results, the **service person or dealer** should order parts through the distributor. Parts can be shipped directly to the **service person/dealer**.

Warranty Parts

Warranty parts will need a proof of purchase and can be ordered by your Service Person or Dealer. Proof of purchase is **required** for warranty parts.

All parts listed in the Parts List have a Part Number. When ordering parts, first obtain the Model Number and Serial Number from the name plate on your equipment. Then determine the Part Number (**not** the Index Number) and the Description of each part from the following illustration and part list. Be sure to give all this information . . .

Appliance Model Number _____ Part Description _____

Appliance Serial Number _____ Part Number _____

Type of Gas (Propane or Natural) _____

Do not order bolts, screws, washers or nuts. They are standard hardware items and can be purchased at any local hardware store.

Shipments contingent upon strikes, fires and all causes beyond our control.

WARRANTY

Empire Comfort Systems Inc. warranties this hearth product to be free from defects at the time of purchase and for the periods specified below. Hearth products must be installed by a qualified technician and must be maintained and operated safely, in accordance with the instructions in the owner's manual. This warranty applies to the original purchaser only and is not transferable. All warranty repairs must be accomplished by a qualified gas appliance technician.

**Limited Five-Year Parts & Labor Warranty – All Other Components
(Except Remote Controls, Thermostats, Accessories and Replacement Parts)**

Should any part fail because of defective workmanship or material within five years from the date of purchase, Empire will repair or replace at Empire's option. Within five years from the date of purchase, Empire will pay reasonable labor to have that defect repaired at Empire's option.

Limited One-Year Parts Warranty – Remote Controls, Thermostats, Accessories, and Parts

Should any remote control, thermostat, accessory, or other part fail because of defective workmanship within one year from the date of purchase, Empire will repair or replace at Empire's option.

Duties Of The Owner

The appliance must be installed by a qualified installer and operated in accordance with the instructions furnished with the appliance. A bill of sale, cancelled check, or payment record should be kept to verify purchase date and establish warranty period. Ready access to the appliance for service.

What Is Not Covered

Damages that might result from the use, misuse, or improper installation of this appliance.
Travel, diagnostic costs and freight charges on warranted parts to and from the factory.
Claims that do not involve defective workmanship or materials.
Unauthorized service or parts replacements.
Removal and reinstallation cost.
Inoperable due to improper or lack of maintenance.

How To Get Service

To make a claim under this warranty, please have your receipt available and contact your installing dealer. Provide the dealer with the model number, serial number, type of gas, and purchase verification. The installing dealer is responsible for providing service and will contact the factory to initiate any warranted parts replacements. Empire will make replacement parts available at the factory. Shipping expenses are not covered.

If, after contacting your Empire dealer, service received has not been satisfactory, contact: Consumer Relations Department, Empire Comfort Systems Inc., PO Box 529, Belleville, Illinois 62222, or send an e-mail to info@empirecomfort.com with "Consumer Relations" in the subject line.

Your Rights Under State Law

This warranty gives your specific legal rights, and you may also have other rights, which vary from state to state.

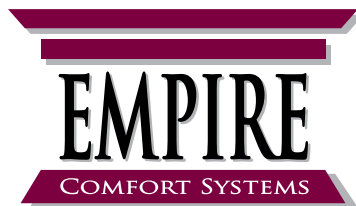

SINCE 1932

www.empirecomfort.com

Empire Comfort Systems Inc.
Belleville, IL

If you have a general question
about our products, please e-mail
us at info@empirecomfort.com.

If you have a service or repair
question, please contact your dealer.